

Koken

HIGH PERFORMANCE TOOLS OF CONVINCING QUALITY

PRODUCT RANGE



2020

 **WHITE**[®]
INTERNATIONAL

Z-SERIES

HAND SOCKETS

SCREWDRIVERS

IMPACT

ACCESSORIES

AUTOMOTIVE

RENEWAL KITS



INDEX

Z-SERIES

P19-27



HAND SOCKETS P29-72



SCREWDRIVERS P75-77



IMPACT

P79-101



ACCESSORIES

P103-114



AUTOMOTIVE

P117-123



RENEWAL KITS

P125-126



■ TEST AND LABORATORY



Ko-ken uses a variety of test equipment. Strength is measured by the Static Load Test Machine that can measure torque load up to 5,000Nm. Durability is measured by the Cyclic Test Machine and corrosion resistance testing is done by the Salt Spray Test Machine. The test results are used to improve our standard products and assist with new product design and development.



■ DESIGN AND DEVELOPMENT

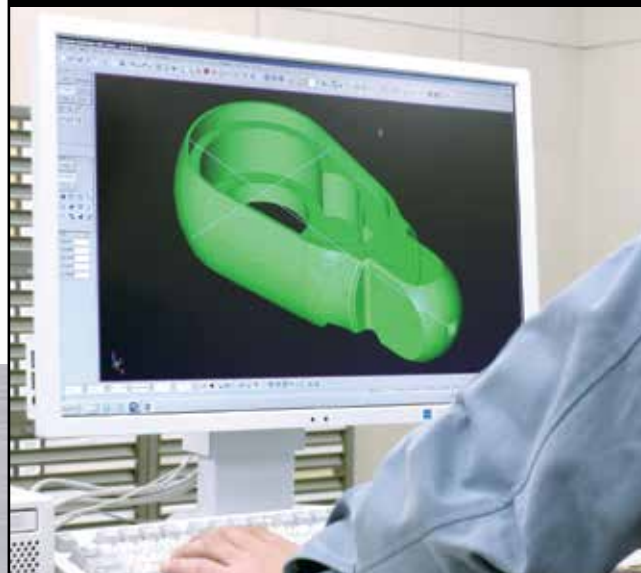

The 3D-CAD is used to improve standard products, designing new products and making customised items for special requirements. Trial products are regularly developed, manufactured and tested to improve the durability, appearance and functionality of all tools produced by Ko-ken.



■ FORGING



The Forging machines are used for the forging process. These machines can produce mass quantities of sockets and parts with high accuracy that ordinary drop forging machines cannot achieve. On the other hand, ordinary forging machines are also used for small production runs.



■ TURNING



The forged steel is turned into required shapes and dimensions. The MC (Machining Centre) operates with extraordinary speed and precision. The article number, size, logo, production number, and MADE IN JAPAN are marked on the products after the turning process has been completed.



■ HEAT TREATMENT



To make the tools stronger and more durable, proper heat treatment is critically important. The temperature and the time of the heat treatment are strictly regulated by a very accurate control device.



■ INSPECTION



Our products are periodically checked at each production process by inspection devices. Highly accurate 3-D measuring instruments are used to inspect and check dimensions.





FLAT DRIVE®

Flat Drive is designed to guarantee a flat surface contact between the socket and the bolt/nut.

The Flat contact reduces wear and allows the user to transmit a higher torque value.

The Flat Drive System is also used for the square drive end as well as the hexagonal or bi-hexagonal openings of the socket.

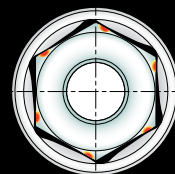

SOCKETS



SURFACE DRIVE



Surface drive sockets are designed to retain contact with flat sides of nut to transmit high torque and reduce nut wear.

These sockets are ideal for use on polished nuts, aluminum nuts and nuts with worn out points.

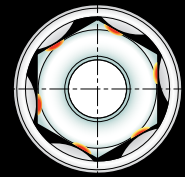

NUT GRIP®



Twin balls at the 6-point opening hold bolt/nut tightly for safe and reliable work.

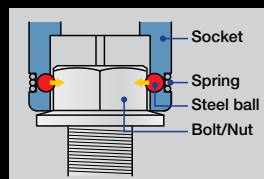

PATHFINDER®



The bevelled flats of the 6-point opening of the PATHFINDER socket engages the nut almost immediately. PATHFINDER sockets are ideal for use with power tools in automatic assembly processes, as the power tool does not have to be totally stopped for the socket to engage the nut.





RATCHET HANDLE



S.O.D.H-System®

Two dogs are located in the ratchet body so that the dogs and springs are held securely in place while allowing the reversing lever and dog to switch smoothly.

The torque load on the gear is transmitted vertically to the dog, and in turn, down the ratchet handle. This mechanism locks gears tightly in place while torque is being applied, thus avoiding any gear slippage.



Two-Step Dog

Two flats hold two teeth of the ratchet gear, thus increasing the maximum torque load of the ratchet compared with a single-step system.

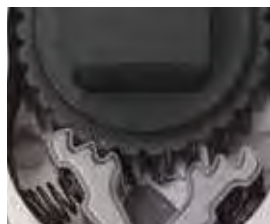

Three-Step Dog

Two dogs are set in the same axis, and the three teeth hold the ratchet gear.

The enlarged contact area produces about 10% higher torque value and the S.O.D.H-System provides smooth and light movements.



SHAPE of HANDLE



OVAL SHAPE SHANK



Unique designed oval shape shank provides extra strength and durability.

KNURLING



Ratchets and Hinge handles have knurling on the grip to ensure the tool can be held securely.

Extension bars also have 6-point knurling on the outside of the female square drive. This gives a grip to hold with your fingers as well as preventing the tool from rolling on flat surfaces.



WOBBLE-FIX



One use as a flexible extension bar permitting movement up to 15° angle and the other as a normal extension bar.

Fix

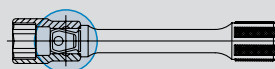

Wobble

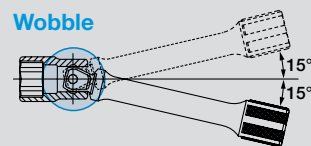



STUD BOLD PULLER/SETTER

STUD BOLT PULLER



The body design was changed to hexagonal shape to minimise tolerances. This shape is also effective to lessen excessive load on cages and rollers inside the body.



RATCHET PULLER



Puller for tightening stud bolts. Go-through body allows puller to grip the stud bolt at any position along the stud. Three-roller protects the bolt from damage.

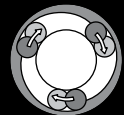

STUD BOLT SETTER



Special socket for installing a stud bolt. The bolt contacts with a steel ball to prevent the bolt from sticking onto the socket. After installing the bolt, turn anti-clockwise to remove the socket.

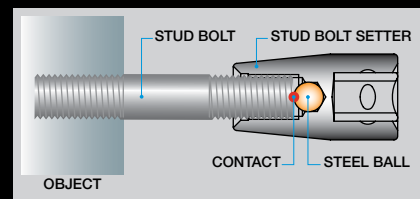



ATTACK DRIVER®

1 BLACK FINISHED HEAD

The top of the Attack Driver is manganese phosphate treated to prevent chrome peeling off the head when it is struck.



1 3 HEAT TREATMENT FOR ANTI-CRACK

Special heat treatment is applied on the parts of Attack Driver. Hardness of striking head is slightly softer to prevent cracking. The cam part has higher hardness to improve anti-wear.

2 BODY SHAPE

Original body shape allows stronger grip. It makes it easier to convert the striking power into twisting power.



3 SPRING

Strong spring is used to convert the striking power efficiently into twisting power.





FREE-TURN GRIP



SPINNING CROSS WRENCH

The shaft of cross wrench turns freely within the knurled grip. The cross bar is removable for easy storage in a compact space.



FLEXIBLE SPEEDER

Free-turn grip allows speedy removal or replacement of wheel nuts. It can also be used as a hinge handle to tighten or loosen the nuts.



SPINNING SLIDE T-HANDLE

The knurled grip is attached in the middle of shaft for free turning. Oval shaped cross bar prevents the bar from turning inside the shaft during use.



IMPACT WHEEL NUT SOCKET



PLASTIC PROTECTOR

A detachable plastic protector is fitted to the socket to prevent damage to the wheel when working in tight areas.

The socket size and Ko-ken Mark printed on the shaft makes it easier to see if the socket is still rotating or stopped.

EXTRA THIN-WALLED



Thin-walled shape and 110mm length gives extra reach for nuts recessed deep inside the wheel.

They are ideal for aluminium wheel nuts where access is very tight. Color coded shafts make size identification easy.

SPARK PLUG SOCKET

CLIP TYPE

It is designed to grip a spark plug securely at its hexagonal part by two stainless spring clips.

Internal brass guide holds the clips in place ensuring perfect alignment of the spark plug into the threaded plughole of the cylinder head and thus preventing thread damage.

The brass guide also eliminates stress loading and possible damage to the ceramic insulator.



UNIVERSAL JOINT

Hexahedral engagement achieved with compact design

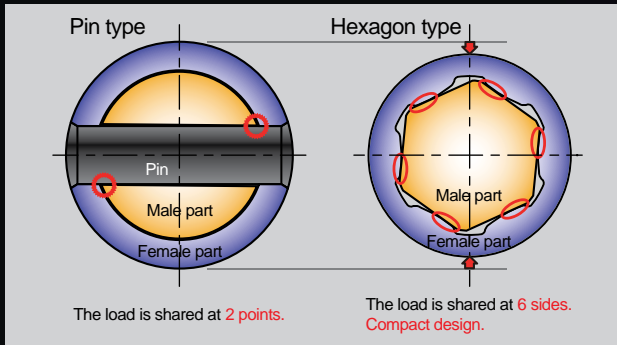

Ball type universal joints use a new structure of joint mechanism without a pin. Being connected by mutually engaged hexahedrons, the load is dispersed across the whole outer circumference. High durability is obtained with this innovative, compact design.



LOCKING ADAPTOR

Impact sockets can be attached or detached on the LOCKING ADAPTOR for safety just by sliding the holder rather than using a pin and an O-ring. It can reduce the time to change a socket, especially when you need to use a variety of socket sizes.

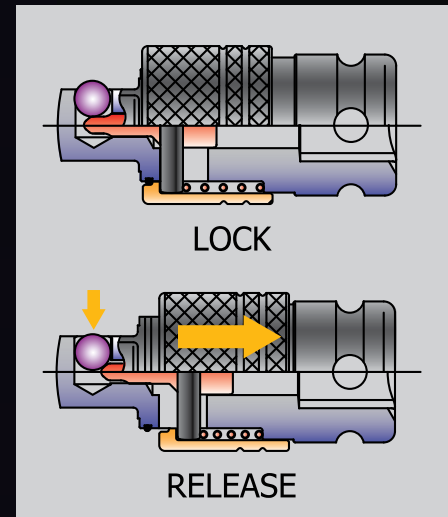

NUTTWISTER®



The NUTTWISTER's six teeth have a special helical structure that tapers inward, locking onto the rounded-off bolt or nut for removal. NUTTWISTER can be applied to any round bolts like stud bolts, cap bolts, provided the correct size is used and the bolt or nut is unbroken.

BOLTTWISTER®

Use the BOLTTWISTER to remove a broken bolt whose head has come off.

After drilling a hole in the center of the broken bolt, insert BOLTTWISTER into the hole and turn it counterclockwise until it sticks.

The bolt can be removed by continuing to turn it.

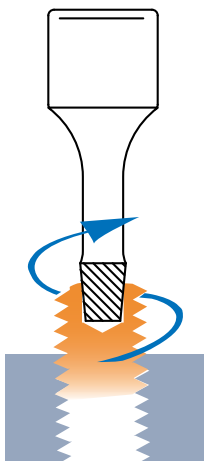

LICENSE



TORX® / TORXplus® are recognised as two of the most efficient fastening systems because of their ability to transfer greater torque, reduce end load and virtually eliminate tool slippage.

TORX® & TORXPLUS®



TORX® and **TORXplus®** are registered trademark of Acument Intellectual Properties, LLC. **Koken TOOL CO., LTD.** holds the official license to use the trademark **TORX®** and **TORXplus®**.

WARRANTY

WARRANTY

The trade mark **Koken** is your unqualified warranty against any defect in material or workmanship. Each **Koken** tool is built to more than meet the requirements of its intended use and is carefully checked before leaving the factory. Any **Koken** tool which fails because of defective material or workmanship will be repaired or replaced through your **Koken** dealer, to the exclusion of any further liability.

GENERAL SAFETY ADVICE

GENERAL

- Make sure you use the right type socket, whose opening fit the nut.
- For use on electric or air IMPACT Wrenches select IMPACT Sockets only.
- When using nut runners or IMPACT Wrenches wear safety goggles.
- Plastic or rubber handles are not intended to act as insulation.
- Never substitute a HAND Socket for an INDUSTRIAL Socket or an IMPACT Socket, or an INDUSTRIAL Socket for an IMPACT Socket.
- Items in this catalogue marked  can be loaded to torque values which may cause breakage. In the interest of your own safety always apply load evenly and progressively to avoid breakage and possible injury.

SOCKETS

Sockets showing cracked walls, battered points or other marks of wear are to be replaced.

HANDLES

A ratchet is not a hammer. Never use loose pipes or other improvised attachments on handles for increased leverage.

EXTENSION BARS

The combination of several short extensions instead of one correct sized one is to be avoided.

ADAPTORS

Adaptors are to be used reasonably. Be reminded that high torque potentials are reached when using a "down" adaptor, a bigger sized handle to a smaller drive socket. Always stay within safe limits.



Z-series



Z-Series : Feature

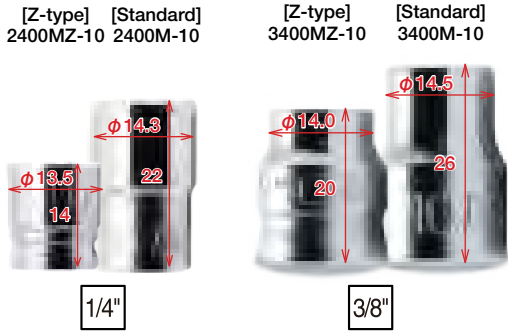

COMPACT

2400MZ, 3400MZ and 4400MZ are designed 5-14mm shorter than standard 2400M, 3400M and 4400M. Ideal for working in confined and tight areas.

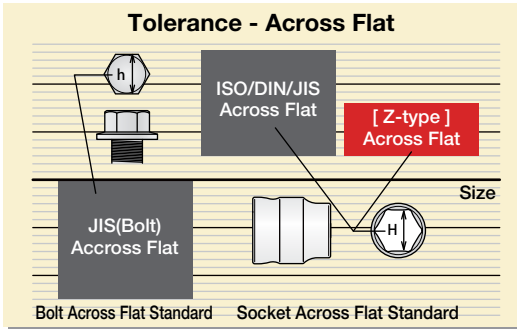

TOLERANCE-Hexagon Opening

Ko-ken standard sockets are manufactured according to DIN/ISO standards. The tolerances of Z-Series sockets are precisely controlled to achieve a more positive fit between bolt and socket.

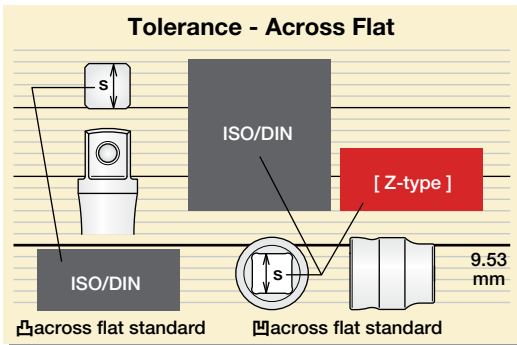

TOLERANCE-Square Drive

Manufacturing tolerance of Male and Female Square are precisely controlled to achieve a more secure fit between Socket and Handle.

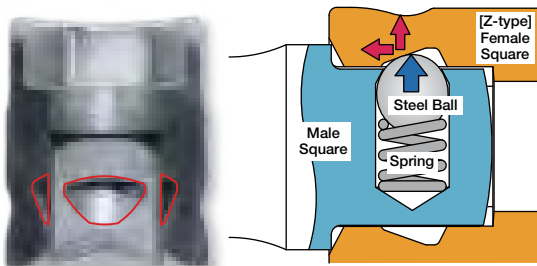

BALL HOLDING GROOVE

Original Ball Holding system is applied on Z-series. This mechanism gives secure connection between Socket and Handle.

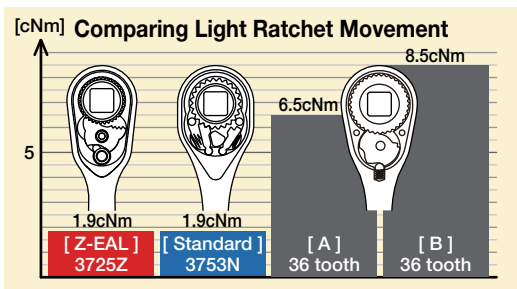

RATCHET HANDLE

Smaller head with 36 tooth gear and light ratchet movement allow working in narrow space and confined areas.

* A, B : Other Brand

1/4" Z-Series Sockets & Accessories

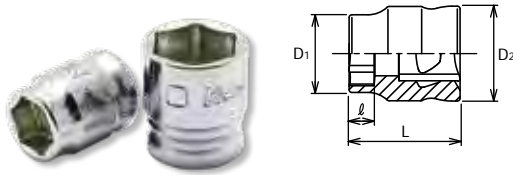

2400MZ 6-point Sockets



Item Code	Part No.	2400MZ (mm)	D ₁ (mm)	D ₂ (mm)	ℓ (mm)	L (mm)	 (g)	 (pcs.)
805794	KO2400MZ04H	4	6.4	11	3	14	6	10
805795	KO2400MZ04.5H	4.5	7	11	3	14	6	10
805796	KO2400MZ05H	5	7.6	11	3	14	6	10
805797	KO2400MZ05.5H	5.5	8.2	11	3.5	14	6	10
805798	KO2400MZ06H	6	8.8	11	3.5	14	6	10
805799	KO2400MZ07H	7	9.9	11	3.5	14	6	10
805800	KO2400MZ08H	8	11.1	11.7	4.5	15	7	10
805801	KO2400MZ10H	10	13.5	12.5	7	15	8	10
805802	KO2400MZ11H	11	14.7	13.2	7	15	9	10
805803	KO2400MZ12H	12	15.9	14.4	7	15	11	10
805804	KO2400MZ13H	13	17.1	15.6	7	15	14	10
805805	KO2400MZ14H	14	18.3	16.8	7	15	16	10

2300MZ 6-point Deep Sockets



Item Code	Part No.	2300MZ (mm)	D ₁ (mm)	D ₂ (mm)	ℓ (mm)	H (mm)	L (mm)	 (g)	 (pcs.)
806772	KO2300MZ04H	4	6.4	11	5	41	50	14	10
806771	KO2300MZ04.5H	4.5	7	11	5.5	41	50	16	10
806774	KO2300MZ05H	5	7.6	11	6	41	50	16	10
806773	KO2300MZ05.5H	5.5	8.2	11	6.5	41	50	16	10
806775	KO2300MZ06H	6	8.8	11	7	41	50	17	10
806776	KO2300MZ07H	7	9.9	11	8	41	50	20	10
806777	KO2300MZ08H	8	11.1	11.7	9	41	50	22	10
806766	KO2300MZ10H	10	13.5	12.5	11	41	50	29	10
806767	KO2300MZ11H	11	14.7	13.2	12	41	50	33	10
806768	KO2300MZ12H	12	15.9	14.4	13	41	50	40	10
806769	KO2300MZ13H	13	17.1	15.6	14	41	50	45	10
806770	KO2300MZ14H	14	18.3	16.8	16	41	50	51	10

RS2400MZ/12 Socket Set on Rail



Item Code	Part No.	Socket Set	 (g)
805285	KORS2400MZ/12	RS2400MZ: 12 Pieces Set/Rail 200mm 4, 4.5, 5, 5.5, 6, 7, 8, 10, 11, 12, 13, 14	228



RS2300MZ/12 Socket Set on Rail



Item Code	Part No.	Socket Set	 (g)
807040	KORS2300MZ/12	RS2300MZ: 12 Pieces Set/Rail 200mm 4, 4.5, 5, 5.5, 6, 7, 8, 10, 11, 12, 13, 14	445

2300XZ 6-point Sockets, Semi-Deep



Item Code	Part No.	2300XZ (mm)	D ₁ (mm)	D ₂ (mm)	ℓ (mm)	H (mm)	L (mm)	 (g)	 (pcs.)
805806	KO2300XZ05.5H	5.5	8.2	11	6	20	30	10	10
805807	KO2300XZ06H	6	8.8	11	7	20	30	10	10
805808	KO2300XZ07H	7	9.9	11	8	20	30	11	10
805809	KO2300XZ08H	8	11.1	11.7	9	20	30	13	10
805810	KO2300XZ10H	10	13.5	12.5	11	20	30	16	10
805811	KO2300XZ11H	11	14.7	13.2	12	20	30	19	10
805812	KO2300XZ12H	12	15.9	14.4	13	20	30	22	10
805813	KO2300XZ13H	13	17.1	15.6	14	20	30	26	10
805814	KO2300XZ14H	14	18.3	16.8	14	20	30	30	10

2725Z Reversible Ratchet

2725Z-160

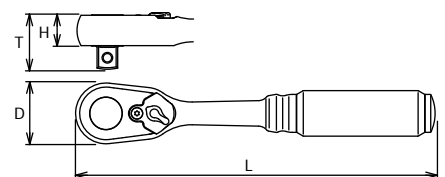

36



RS2300XZ/9 Socket Set on Rail



Item Code	Part No.	Socket Set	 (g)
805286	KORS2300XZ/9	RS2300XZ: 9 Pieces Set/Rail 200mm 5.5, 6, 7, 8, 10, 11, 12, 13, 14	290

Item Code	Part No.	D (mm)	T (mm)	H (mm)	L (mm)	 (g)	 (pcs.)
805291	KO2725Z	20.5	17.1	9.5	114	79	2
806797	KO2725Z-160	20.5	17.1	9.5	160	120	2

* Renewal Kits 2725RK

1/4" Z-Series Sockets & Accessories

Z-SERIES

2726Z Flexible Ratchet, Reversible (Short)
2726Z-160

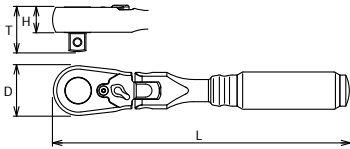

Item Code	Part No.	D (mm)	T (mm)	H (mm)	L (mm)	(g)	(pcs.)
806799	KO2726Z	20.5	17.1	9.5	114	103	2
806800	KO2726Z-160	20.5	17.1	9.5	160	150	2

* Renewal Kits 2725RK

HAND SOCKETS

P2285Z Socket Set



26 Piece Set
 PLASTIC CASE:W245xH120xT45mm

(g) = 660

Item Code	Part No.	Sockets	Accessories
805391	KOP2285Z	2400MZ 6-pt. Sockets 4, 4.5, 5, 5.5, 6, 7, 8, 10, 11, 12, 13, 14	2725Z
		2000Z.28 Bit Sockets 1, 2, 3	2756Z
		2005Z.25 Bit Sockets 5, 6	2771Z
		2010MZ.25 Bit Sockets 3, 4, 5, 6	2760Z-50 760Z-150

SCREWDRIVERS

2760Z Extension Bars

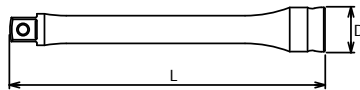

Item Code	Part No.	D (mm)	L (mm)	(g)	(pcs.)
806809	KO2760Z50	11.5	50	21	10
806807	KO2760Z100	11.5	100	39	10
806808	KO2760Z150	11.5	150	58	10

IMPACT

ACCESSORIES

2771Z Universal Joint

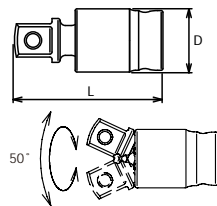

Item Code	Part No.	D (mm)	L (mm)	(g)	(pcs.)
805292	KO2771Z	11.7	29.9	15	10

AUTOMOTIVE

RENEWAL KITS

2772Z Universal Double Joint

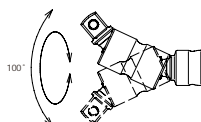
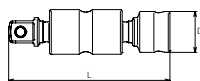



Item Code	Part No.	D (mm)	L (mm)	(g)	(pcs.)
806160	KO2772Z	11.7	46	26	10

3/8" Z-Series Sockets & Accessories

3400MZ 6-point Sockets



Item Code	Part No.	3400MZ (mm)	D ₁ (mm)	D ₂ (mm)	ℓ (mm)	L (mm)	 (g)	 (pcs.)
806904	KO3400MZ05.5H	5.5	8.5	17	3.5	19	16	10
806905	KO3400MZ06H	6	9.1	17	3.5	19	17	10
805815	KO3400MZ07H	7	10.3	17	3.5	19	17	10
805816	KO3400MZ08H	8	11.5	17	4.5	20	17	10
805817	KO3400MZ10H	10	14	17	4.5	20	18	10
805818	KO3400MZ11H	11	15.3	17	5.5	21	18	10
805819	KO3400MZ12H	12	16.5	17	5.5	21	19	10
805820	KO3400MZ13H	13	17.8	17	8.5	21	19	10
805821	KO3400MZ14H	14	19	17	8.5	21	20	10
805822	KO3400MZ15H	15	20.2	18.2	8.5	21	24	10
805823	KO3400MZ16H	16	21.3	19.3	8.5	21	28	10
805824	KO3400MZ17H	17	22.5	20.5	8.5	21	32	10
805825	KO3400MZ18H	18	23.6	21.6	9.5	22	38	10
805826	KO3400MZ19H	19	24.8	22.8	9.5	22	41	10
806902	KO3400MZ21H	21	27	25	10.5	23	51	10
806903	KO3400MZ22H	22	28.3	26.3	10.5	23	58	10

3400MZ is designed 5-9mm shorter than standard 3400M.
Ideal for working in confined and tight areas.

RS3300XZ/12 Socket Set on Rail



Item Code	Part No.	Socket Set	 (g)
805288	KORS3300XZ/12	RS3300XZ: 12 Pieces Set/Rail 300mm 7, 8, 10, 11, 12, 13, 14, 15, 16, 17, 18, 19	630

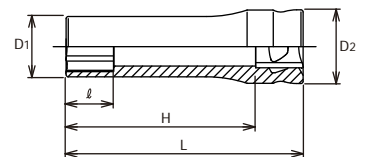

3300MZ 6-point Deep Sockets



RS3400MZ/12 Socket Set on Rail





Item Code	Part No.	Socket Set	 (g)
805287	KORS3400MZ/12	RS3400MZ: 12 Pieces Set/Rail 300mm 7, 8, 10, 11, 12, 13, 14, 15, 16, 17, 18, 19	490

Item Code	Part No.	3300MZ (mm)	D ₁ (mm)	D ₂ (mm)	ℓ (mm)	H (mm)	L (mm)	 (g)	 (pcs.)
805839	KO3300MZ07H	7	10.3	17	8	41.5	55	29	10
805840	KO3300MZ08H	8	11.5	17	9	41.5	55	34	10
805841	KO3300MZ10H	10	14	17	11	41.5	55	43	10
805842	KO3300MZ11H	11	15.3	17	12	41.5	55	45	10
805843	KO3300MZ12H	12	16.5	17	13	41.5	55	49	10
805844	KO3300MZ13H	13	17.8	17	14	41.5	55	52	10
805845	KO3300MZ14H	14	19	17	16	41.5	55	55	10
805846	KO3300MZ15H	15	20.2	18.2	16	40.5	55	65	10
805847	KO3300MZ16H	16	21.3	19.3	17	40.5	55	74	10
805848	KO3300MZ17H	17	22.5	20.5	18	40.5	55	83	10
805849	KO3300MZ18H	18	23.6	21.6	19	39.5	55	90	10
805850	KO3300MZ19H	19	24.8	22.8	20	39.5	55	95	10

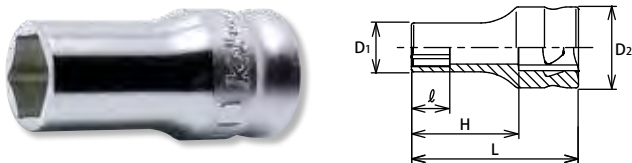
3300XZ 6-point Sockets, Semi-Deep



Item Code	Part No.	3300XZ (mm)	D ₁ (mm)	D ₂ (mm)	ℓ (mm)	H (mm)	L (mm)	 (g)	 (pcs.)
805827	KO3300XZ07H	7	10.3	17	8	23	35	23	10
805828	KO3300XZ08H	8	11.5	17	9	23	35	24	10
805829	KO3300XZ10H	10	14	17	11	23	35	26	10
805830	KO3300XZ11H	11	15.3	17	12	23	35	28	10
805831	KO3300XZ12H	12	16.5	17	13	23	35	29	10
805832	KO3300XZ13H	13	17.8	17	14	23	35	32	10
805833	KO3300XZ14H	14	19	17	16	23	35	34	10
805834	KO3300XZ15H	15	20.2	18.2	16	23	35	40	10
805835	KO3300XZ16H	16	21.3	19.3	16.5	23	35	45	10
805836	KO3300XZ17H	17	22.5	20.5	16.5	23	35	50	10
805837	KO3300XZ18H	18	23.6	21.6	16.5	23	35	56	10
805838	KO3300XZ19H	19	24.8	22.8	18	23	35	60	10

RS3300MZ/12 Socket Set on Rail



Item Code	Part No.	Socket Set	 (g)
805289	KORS3300MZ/12	RS3300MZ: 12 Pieces Set/Rail 300mm 7, 8, 10, 11, 12, 13, 14, 15, 16, 17, 18, 19	900

3/8" Z-Series Sockets & Accessories

Z-SERIES

HAND SOCKETS

3300CZ Spark Plug Sockets with Spring Clips

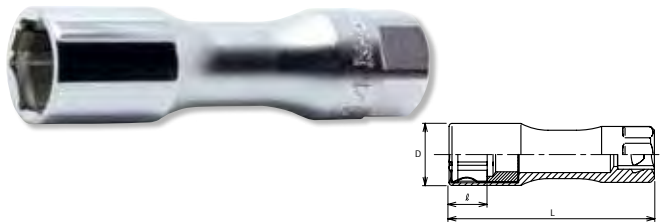

Item Code	Part No.	3300CZ (mm)	D (mm)	ℓ (mm)	L (mm)	(g)	(pcs.)
806867	KO3300CZ-14	14	18.4	11	70	67	10
806868	KO3300CZ-16	16	20.5	13	70	71	10
805389	KO3300CZ-18	18	22.9	12	70	75	10
805389	KO3300CZ-20.8	20.8	26.3	13.5	70	105	10

Slim & light weight body with smaller outside diameter for work in tight spaces.

RS3010MZ/8-L50 Socket Set on Rail



Item Code	Part No.	Socket Set	(g)
805387	KORS3010MZ/8-L50	RS3010MZ-50: 8 Pieces Set/Rail 200mm 3, 4, 5, 6, 7, 8, 10, 12	460

SCREWDRIVERS

3305PZ Spark Plug Socket with Magnet, 12-pt. opening



Item Code	Part No.	3305PZ (mm)	D (mm)	ℓ (mm)	L (mm)	(g)	(pcs.)
805295	KO3305PZ-14	14	17.9	8	70	56	10
805388	KO3305PZ-16	16	20	8	70	55	10

Spark Plug Socket with Magnet, 12-pt. opening: size 14mm

3025Z-50 TORX® Bit Sockets

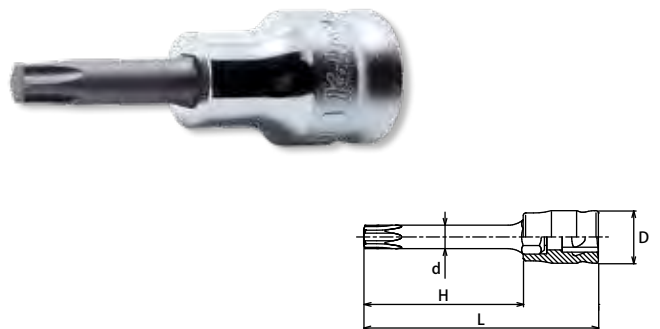

Item Code	Part No.	3025Z.50 (T)	D (mm)	d (mm)	H (mm)	L (mm)	(g)	(pcs.)
805861	KO3025Z50T20H	T20	17	3.9	23.5	50	28	10
805862	KO3025Z50T25H	T25	17	4.5	23.5	50	29	10
805863	KO3025Z50T27H	T27	17	5	23.5	50	30	10
805864	KO3025Z50T30H	T30	17	5.6	23.5	50	31	10
805865	KO3025Z50T40H	T40	17	6.7	23.5	50	35	10
805866	KO3025Z50T45H	T45	17	7.83	23.5	50	38	10
805867	KO3025Z50T50H	T50	17	8.90	23.5	50	48	10
805868	KO3025Z50T55H	T55	19	11.3	23.5	50	70	10

IMPACT

ACCESSORIES

3010MZ-50 Inhex Bit Sockets

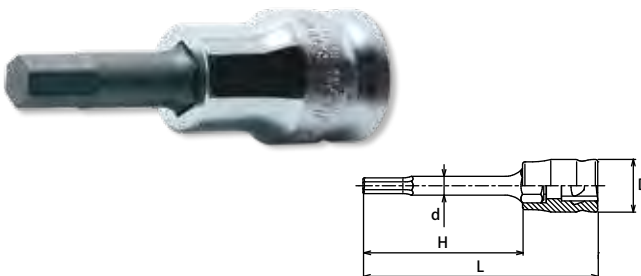

Item Code	Part No.	3010MZ.50 (mm)	D (mm)	d (mm)	H (mm)	L (mm)	(g)	(pcs.)
805869	KO3010MZ5003H	3	17	4	23.5	50	28	10
805870	KO3010MZ5004H	4	17	5	23.5	50	29	10
805871	KO3010MZ5005H	5	17	6	23.5	50	30	10
805872	KO3010MZ5006H	6	17	7	23.5	50	35	10
805873	KO3010MZ5007H	7	17	-	23.5	50	38	10
805874	KO3010MZ5008H	8	17	-	23.5	50	40	10
805875	KO3010MZ5010H	10	17	-	23.5	50	50	10
805876	KO3010MZ5012H	12	19	-	23.5	50	70	10

RS3025Z/8-L50 Socket Set on Rail



Item Code	Part No.	Socket Set	(g)
805386	KORS3025Z/8-L50	RS3025Z-50: 8 Pieces Set/Rail 200mm T20, T25, T27, T30, T40, T45, T50, T55	450

AUTOMOTIVE

RENEWAL KITS

3/8" Z-Series Sockets & Accessories

2725Z-3/8 Reversible Ratchet Short

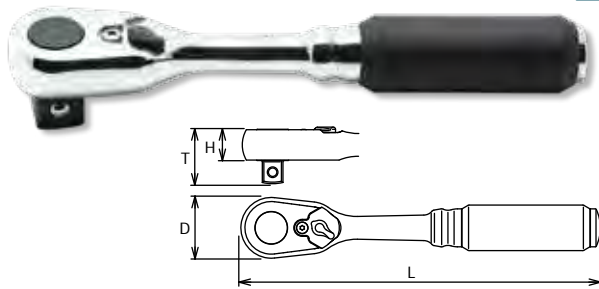

36

Item Code	Part No.	D (mm)	T (mm)	H (mm)	L (mm)	(g)	(pcs.)
806798	KO2725Z-3/8	20.5	20.5	9.5	114	83	2

3726Z Flexible Ratchet, Reversible
3726Z-280

OVAL Shank 36 Flexible Head

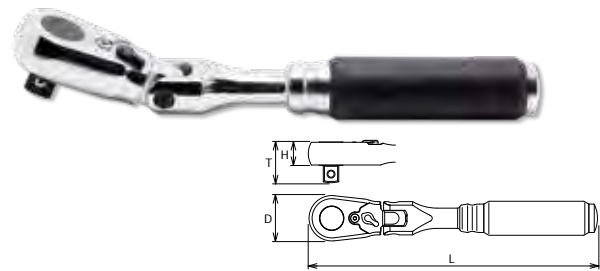

Item Code	Part No.	D (mm)	T (mm)	H (mm)	L (mm)	(g)	(pce.)
806917	KO3726Z	28	24.5	13.7	178	317	1
807087	KO3726Z-280	28	24.5	13.7	280	420	1

* Renewal Kits 3725RK

3725Z Reversible Ratchet
3725Z-280

36

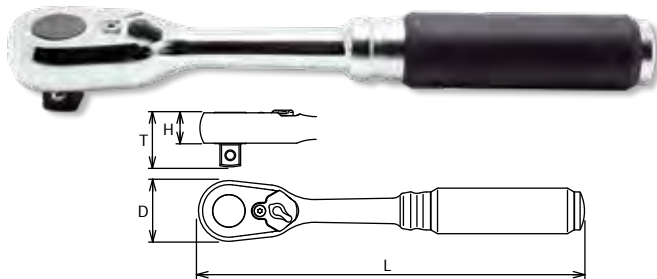

Item Code	Part No.	D (mm)	T (mm)	H (mm)	L (mm)	(g)	(pce.)
805293	KO3725Z	28	24.5	13.7	178	254	1
806916	KO3725Z-280	28	24.5	13.7	280	360	1

* Renewal Kits 3725RK

3760Z-75 · -125 · -250 Extension Bars

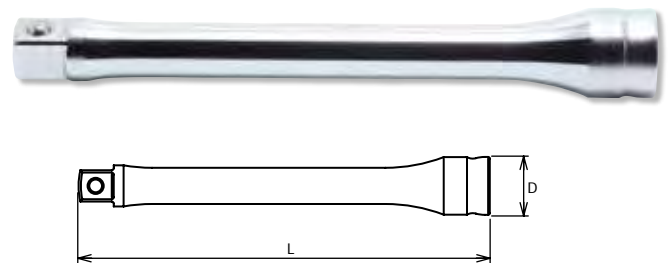

Item Code	Part No.	D (mm)	L (mm)	(g)	(pcs.)
806925	KO3760Z75	17.5	75	66	10
806923	KO3760Z125	17.5	125	103	10
806924	KO3760Z250	17.5	250	195	5

2726Z-3/8 Flexible Ratchet, Reversible (Short)

36 Flexible Head

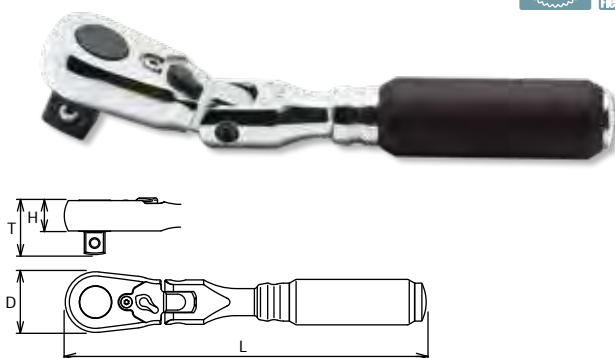

Item Code	Part No.	D (mm)	T (mm)	H (mm)	L (mm)	(g)	(pcs.)
806801	KO2726Z-3/8	20.5	20.5	9.5	114	107	2

3771Z Universal Joint



Item Code	Part No.	D (mm)	L (mm)	(g)	(pcs.)
805294	KO3771Z	18	42.5	44	10

3772Z Universal Double Joint

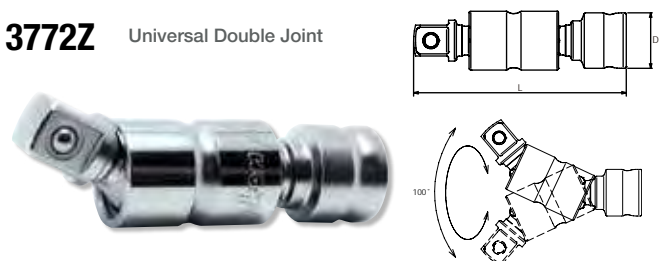



Item Code	Part No.	D (mm)	L (mm)	(g)	(pcs.)
806159	KO3772Z	17	65	76	10

1/2" Z-Series Sockets & Accessories

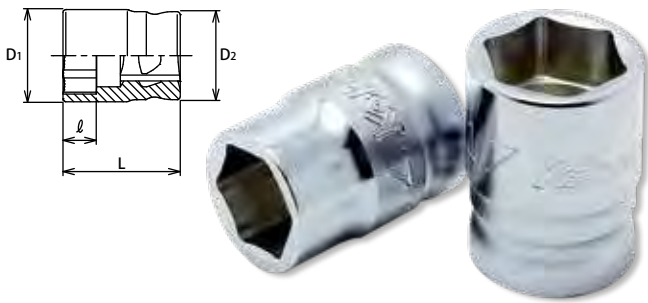

4400MZ 6-point Sockets



Item Code	Part No.	4400MZ (mm)	D ₁ (mm)	D ₂ (mm)	l (mm)	L (mm)	 (g)	 (pcs.)
806964	KO4400MZ08H	8	12.6	20.6	4.5	26	30	10
805851	KO4400MZ10H	10	15	20.6	4.5	26	31	10
805852	KO4400MZ12H	12	17	20.6	5.5	27	32	10
805853	KO4400MZ13H	13	18.3	21.5	6.5	28	40	10
805854	KO4400MZ14H	14	19.5	21.5	6.5	28	40	10
806963	KO4400MZ16H	16	22	21.5	7.5	28	43	10
805855	KO4400MZ17H	17	23	22.5	7.5	29	49	10
807088	KO4400MZ18	18	24.1	23.7	7.5	29	56	10
805856	KO4400MZ19H	19	25.3	24.4	9.5	29	62	10
805857	KO4400MZ21H	21	27.6	26.3	10.5	29	76	10
805858	KO4400MZ22H	22	28.8	27.5	11	29	83	10
805859	KO4400MZ24H	24	31.1	29.2	12	29	96	5
805860	KO4400MZ27H	27	34.6	32.2	13.5	30	124	5
805392	KO4400MZ30	30	38.1	35.2	14.5	31	156	5
805393	KO4400MZ32	32	40.4	36.8	15.5	32	178	5

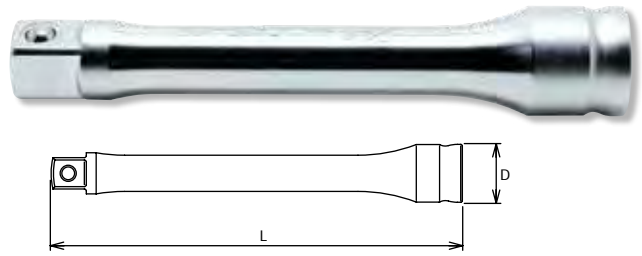

4760Z-125 • -250 Extension Bars



Item Code	Part No.	4760Z	D (mm)	L (mm)	 (g)	 (pcs.)
806982	KO4760Z125	125	22.5	125	180	5
806983	KO4760Z250	250	22.5	250	340	5

4771Z Universal Joint



Item Code	Part No.	D (mm)	L (mm)	 (g)	 (pcs.)
805297	KO4771Z	23.7	55.8	100	10



RS4400MZ/10 Socket Set on Rail

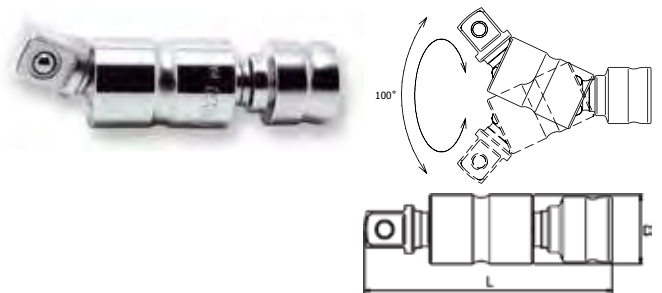

Item Code	Part No.	Socket Set	 (g)
805290	KORS4400MZ/10	RS4400MZ: 10 Pieces Set/Rail 300mm 10, 12, 13, 14, 17, 19, 21, 22, 24, 27	830

4772Z Universal Double Joint





Item Code	Part No.	D (mm)	L (mm)	 (g)	 (pcs.)
806985	KO4772Z	23.7	87.2	170	5

4725Z Reversible Ratchet

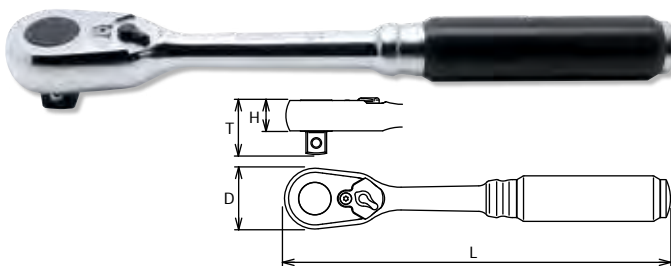
36





Item Code	Part No.	D (mm)	T (mm)	H (mm)	L (mm)	 (g)	 (pce.)
805296	KO4725Z	36.5	32.8	18.2	253	590	1

* Renewal Kits -- 4725RK

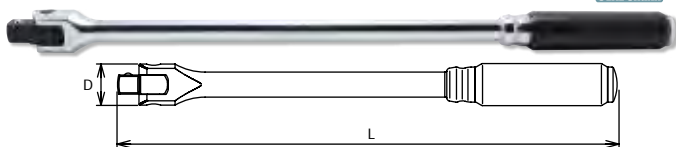
4768Z-430 Hinge Handle



Item Code	Part No.	D (mm)	L (mm)	 (g)	 (pcs.)
805298	KO4768Z-430	28	430	720	2

* Renewal Kits -- 4768ZRK

Z-SERIES

HAND SOCKETS

SCREWDRIVERS

IMPACT

ACCESSORIES

AUTOMOTIVE

RENEWAL KITS

RSAL200-1/4x12

RSAL300-3/8x12 · -1/2x10

Magnetic Rail with Clips

RSAL-200 · -300 · -400



Item Code	Part No.	□	RAIL (mm)	CLIP (pcs.)	⚖️ (g)	📎 (pce.)
805383	KORSAL200-1/4X12	1/4"	200	12	125	1
805384	KORSAL300-3/8X12	3/8"	300	12	180	1
805385	KORSAL300-1/2X10	1/2"	300	10	190	1

Item Code	Part No.	RAIL (mm)	⚖️ (g)	📎 (pce.)
807092	KORSAL200	200	110	1
807093	KORSAL300	300	145	1
807094	KORSAL400	400	210	1

CLIP.P/5-1/4 · -3/8 · -1/2

Clip for Magnetic Rail



Item Code	Part No.	□	⚖️ (g)	📎 (pce.)
807027	KOCLIP.P/5-1/4	1/4"	10	5
807028	KOCLIP.P/5-3/8	3/8"	13	5
807026	KOCLIP.P/5-1/2	1/2"	20	5

Z-SERIES

HAND SOCKETS

SCREWDRIVERS

IMPACT

ACCESSORIES

AUTOMOTIVE

RENEWAL KITS

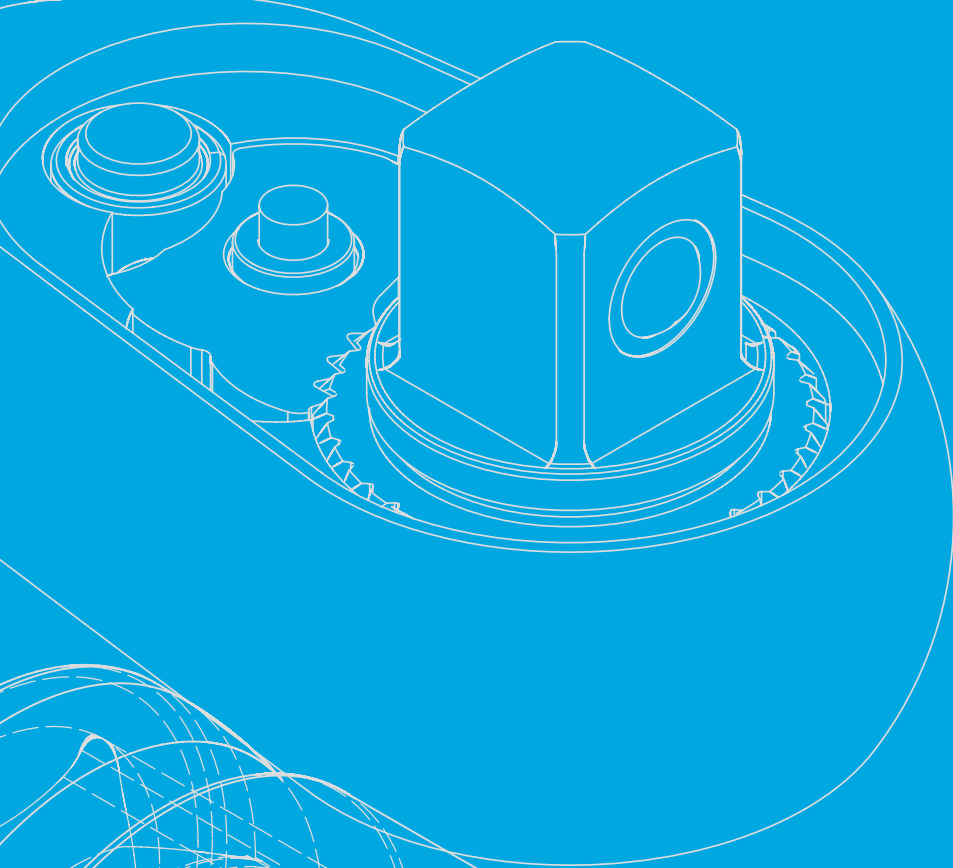
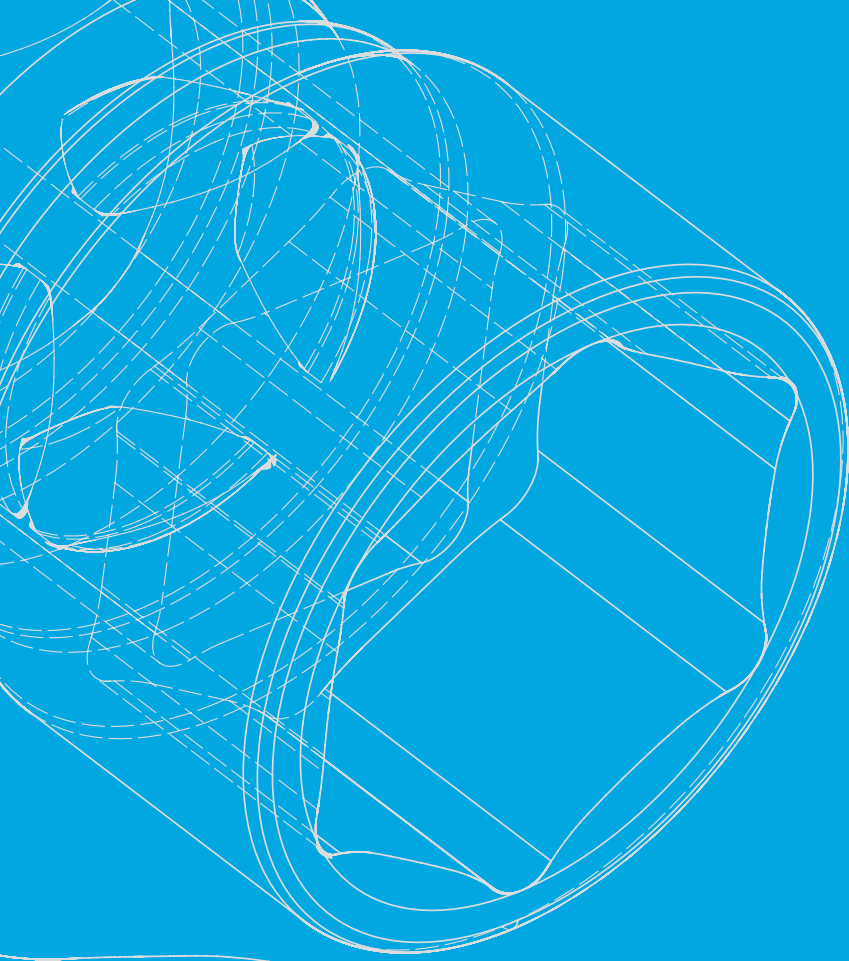

Hand Sockets

1/4"

3/8"

1/2"

3/4"

1"



1/4" Sockets & Accessories

2400M 2400A

6-point Sockets

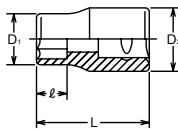

Item Code	Part No.	2400M (mm)	D ₁ (mm)	D ₂ (mm)	ℓ (mm)	L (mm)	(g)	(pcs.)
504326 [^]	KO2400M03	3	5.5	11.2	2.6	22	7	10
504327 [^]	KO2400M04	4	6.7	11.2	3.5	22	8	10
504328 [^]	KO2400M04.5	4.5	7.3	11.2	4	22	8	10
504329	KO2400M05	5	8	11.2	5	22	8	10
504330	KO2400M05.5	5.5	8.5	11.2	5.5	22	9	10
504331	KO2400M06	6	9.2	11.2	5.5	22	9	10
504332	KO2400M07	7	10.3	11.2	6	22	9	10
504333	KO2400M08	8	11.2	11.7	6.9	22	11	10
504334	KO2400M09	9	13	12	7.3	22	12	10
504335	KO2400M10	10	14.3	12.9	7.7	22	15	10
504336	KO2400M11	11	15.5	14.3	9.3	22	18	10
504337	KO2400M12	12	16.8	15.5	9.3	22	23	10
504338	KO2400M13	13	18	16.4	9.8	22	23	10
504339	KO2400M14	14	19.3	17.9	11	24	30	10

Item Code	Part No.	2400A (inch)	D ₁ (mm)	D ₂ (mm)	ℓ (mm)	L (mm)	(g)	(pcs.)
504315	KO2400A04	1/8	5.7	11.2	2.7	22	7	10
511203	KO2400A05	5/32	6.7	11.2	3.5	22	8	10
504316	KO2400A06	3/16	7.8	11.2	5	22	8	10
504317	KO2400A07	7/32	8.5	11.2	5.5	22	9	10
504318	KO2400A08	1/4	9.6	11.2	5.8	22	9	10
504319	KO2400A09	9/32	10.3	11.2	6	22	9	10
504320	KO2400A10	5/16	11.2	11.7	6.9	22	11	10
504321	KO2400A11	11/32	12.5	11.7	7.3	22	12	10
504322	KO2400A12	3/8	13.7	12.5	7.7	22	15	10
504323	KO2400A14	7/16	15.5	14.3	9.3	22	18	10
504324	KO2400A16	1/2	18	16.4	9.8	22	23	10
504325	KO2400A18	9/16	19.3	17.9	11	24	30	10

2405M 2405A

12-point Sockets

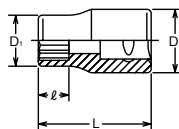

Item Code	Part No.	2405M (mm)	D ₁ (mm)	D ₂ (mm)	ℓ (mm)	L (mm)	(g)	(pcs.)
504351 [^]	KO2405M03	3	5.5	11.2	2.6	22	7	10
504352 [^]	KO2405M04	4	6.7	11.2	3.5	22	8	10
504353 [^]	KO2405M04.5	4.5	7.3	11.2	4	22	8	10
504354	KO2405M05	5	8	11.2	5	22	8	10
504355	KO2405M05.5	5.5	8.5	11.2	5.5	22	9	10
504356	KO2405M06	6	9.2	11.2	5.5	22	9	10
504357	KO2405M07	7	10.3	11.2	6	22	9	10
504358	KO2405M08	8	11.2	11.7	6.9	22	11	10
504359	KO2405M09	9	13	12	7.3	22	12	10
504360	KO2405M10	10	14.3	12.9	7.7	22	15	10
504361	KO2405M11	11	15.5	14.3	9.3	22	18	10
504362	KO2405M12	12	16.8	15.5	9.3	22	23	10
504363	KO2405M13	13	18	16.4	9.8	22	23	10
504364	KO2405M14	14	19.3	17.9	11	24	30	10

Item Code	Part No.	2405A (inch)	D ₁ (mm)	D ₂ (mm)	ℓ (mm)	L (mm)	(g)	(pcs.)
504340 [^]	KO2405A04	1/8	5.7	11.2	2.7	22	7	10
504341	KO2405A06	3/16	7.8	11.2	5	22	8	10
504342	KO2405A07	7/32	8.5	11.2	5.5	22	9	10
504343	KO2405A08	1/4	9.6	11.2	5.8	22	9	10
504344	KO2405A09	9/32	10.3	11.2	6	22	9	10
504345	KO2405A10	5/16	11.2	11.7	6.9	22	11	10
504346	KO2405A11	11/32	12.5	11.7	7.3	22	12	10
504347	KO2405A12	3/8	13.7	12.5	7.7	22	15	10
504348	KO2405A14	7/16	15.5	14.3	9.3	22	18	10
504349	KO2405A16	1/2	18	16.4	9.8	22	23	10
504350	KO2405A18	9/16	19.3	17.9	11	24	30	10

RS2400M/11 RS2405M/11

Socket Set on Rail



Item Code	Part No.	Socket Sets	(g)
505554	KORS2400M/11	RS2400M: 11 Pieces Set/Rail 200mm 4, 5, 6, 7, 8, 9, 10, 11, 12, 13, 14	222
505557	KORS2405M/11	RS2405M: 11 Pieces Set/Rail 200mm 4, 5, 6, 7, 8, 9, 10, 11, 12, 13, 14	222

RS2400A/9 RS2405A/9

Socket Set on Rail



Item Code	Part No.	Socket Sets	(g)
505553	KORS2400A/9	RS2400A: 9 Pieces Set/Rail 150mm 3/16, 7/32, 1/4, 9/32, 5/16, 11/32, 3/8, 7/16, 1/2"	162
505556	KORS2405A/9	RS2405A: 9 Pieces Set/Rail 150mm 3/16, 7/32, 1/4, 9/32, 5/16, 11/32, 3/8, 7/16, 1/2"	162

RSAS2405A/10

12-point Socket Set on Rail



Item Code	Part No.	Socket Sets	(g)
505615 [^]	KORSAS2405A/10	RSAS2405A: 10 Pieces Set/Rail 150mm 3/16, 7/32, 1/4, 9/32, 5/16, 11/32, 3/8, 7/16, 1/2, 9/16"	160

Aerospace Standard SAE AS954

2400W-BA

6-point Whitworth Sockets

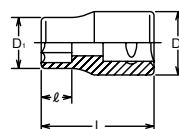

Item Code	Part No.	2400W (BA)	D ₁ (mm)	D ₂ (mm)	ℓ (mm)	L (mm)	(g)	(pcs.)
806790 [^]	KO2400W-BA8	8	6.1	11.2	3	22	7	10
806789 [^]	KO2400W-BA7	7	7.3	11.2	4	22	8	10
806788 [^]	KO2400W-BA6	6	8	11.2	5	22	8	10
806787 [^]	KO2400W-BA5	5	8.5	11.2	5.5	22	9	10
806786 [^]	KO2400W-BA4	4	9.6	11.2	5.8	22	9	10
806785 [^]	KO2400W-BA3	3	10.3	11.2	6	22	9	10
806784 [^]	KO2400W-BA2	2	11.2	11.7	6.9	22	11	10
806783 [^]	KO2400W-BA1	1	13	12	7.3	22	12	10
806782 [^]	KO2400W-BA0	0	14.9	13.6	8	22	16	10

1/4" Sockets & Accessories

RS2400W/9-BA 6 Point Whitworth Socket Set on Rail





Item Code	Part No.	Socket Set	 (g)
505555	KORS2400W/9-BA	RS2400W: 9 Pieces Set/Rail 150mm 8, 7, 6, 5, 4, 3, 2, 1, 0	120

	Across Flat									
	BA	8BA	7BA	6BA	5BA	4BA	3BA	2BA	1BA	0BA
S	(ref. mm)	3.86	4.37	4.90	5.59	6.30	7.16	8.23	9.27	10.49
	(ref. in)	0.152	0.172	0.193	0.220	0.248	0.282	0.324	0.365	0.413

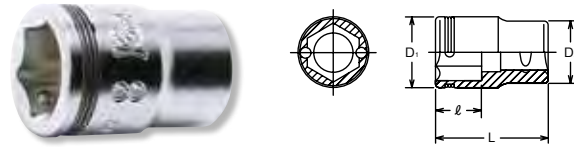
2450MS Nut Grip Sockets Nut Grip®







Item Code	Part No.	2450MS (mm)	D ₁ (mm)	D ₂ (mm)	ℓ (mm)	L (mm)	 (g)	 (pcs.)
806795 [^]	KO2450MS07	7	11.3	11.2	4	18	8	10
806796 [^]	KO2450MS08	8	12.3	11.2	5	18	9	10
806791 [^]	KO2450MS10	10	14.3	12.9	6	19	13	10
806792 [^]	KO2450MS12	12	17.4	16	7	20	22	10
806793 [^]	KO2450MS13	13	18	16.4	8	20	22	10
806794 [^]	KO2450MS14	14	19.9	18	8.5	22	31	10

2415M Double Square Sockets

2415A





Item Code	Part No.	2415M (mm)	D ₁ (mm)	D ₂ (mm)	ℓ (mm)	L (mm)	 (g)	 (pcs.)
504368 [^]	KO2415M06	6	11	11.7	5.4	22	13	10
504369 [^]	KO2415M08	8	14.3	12.9	6.8	22	17	10
504370 [^]	KO2415M10	10	17.4	16	8.2	22	27	10

Item Code	Part No.	2415A (inch)	D ₁ (mm)	D ₂ (mm)	ℓ (mm)	L (mm)	 (g)	 (pcs.)
504365 [^]	KO2415A08	1/4	11	11.7	5.4	22	14	10
504366 [^]	KO2415A10	5/16	14.3	12.9	6.8	22	17	10
504367 [^]	KO2415A12	3/8	17.4	16	8.2	22	26	10

2425 TORX® Sockets



Item Code	Part No.	2425 (E)	D ₁ (mm)	D ₂ (mm)	ℓ (mm)	L (mm)	 (g)	 (pcs.)
805496 [^]	KO2425E04	E 4	5.4	11.2	4.6	22	7	10
805497 [^]	KO2425E05	E 5	6.7	11.2	5.2	22	8	10
805498 [^]	KO2425E06	E 6	7.7	11.2	5.4	22	8	10
805499 [^]	KO2425E07	E 7	8.3	11.2	6.6	22	9	10
805500 [^]	KO2425E08	E 8	9.6	11.2	7	22	9	10
805484 [^]	KO2425E10	E10	11.3	12	8.2	22	10	10

RS2425/6 TORX® Socket Set on Rail



Item Code	Part No.	Torx Socket Set	 (g)
505558	KORS2425/6	RS2425: 6 Pieces Set/Rail 150mm E4, E5, E6, E7, E8, E10	85

RS2450MS/6 Nut Grip Socket Set on Rail







Item Code	Part No.	Socket Sets	 (g)
807034 [^]	KORS2450MS/6	RS2450MS: 6 Pieces Set/Rail 150mm 7, 8, 10, 12, 13, 14	120

2300M 6-point Deep Sockets

2300A



Item Code	Part No.	2300M (mm)	D ₁ (mm)	D ₂ (mm)	ℓ (mm)	L (mm)	 (g)	 (pcs.)
504277 [^]	KO2300M03	3	5.5	11.2	3	50	15	10
504278	KO2300M04	4	6.7	11.2	4	50	15	10
504279	KO2300M05	5	8	11.2	5.5	50	17	10
805463	KO2300M5.5	5.5	8.5	11.2	6	50	17	10
504280	KO2300M06	6	9.2	11.2	7	50	20	10
504281	KO2300M07	7	10.5	11.2	8	50	25	10
504282	KO2300M08	8	11.8	11.2	9	50	25	10
504283	KO2300M09	9	13	12	10	50	30	10
504284	KO2300M10	10	14.3	12.9	11	50	34	10
504285	KO2300M11	11	15.5	14.3	12	50	43	10
504286	KO2300M12	12	16.8	15.5	13	50	50	10
504287	KO2300M13	13	18	16.4	14	50	52	10
504288	KO2300M14	14	19.3	17.9	16	50	57	10

Item Code	Part No.	2300A (inch)	D ₁ (mm)	D ₂ (mm)	ℓ (mm)	L (mm)	 (g)	 (pcs.)
504266	KO2300A04	1/8	5.7	11.2	3.5	50	15	10
511202	KO2300A05	5/32	6.7	11.2	4	50	15	10
504267	KO2300A06	3/16	7.8	11.2	5.5	50	17	10
504268	KO2300A07	7/32	8.5	11.2	6	50	17	10
504269	KO2300A08	1/4	9.8	11.2	7	50	25	10
504270	KO2300A09	9/32	10.5	11.2	8	50	25	10
504271	KO2300A10	5/16	11.8	11.7	9	50	25	10
504272	KO2300A11	11/32	12.5	11.7	10	50	30	10
504273	KO2300A12	3/8	13.7	12.5	11	50	34	10
504274	KO2300A14	7/16	15.5	14.3	12	50	43	10
504275	KO2300A16	1/2	18.0	16.4	14	50	52	10
504276	KO2300A18	9/16	19.3	17.9	16	50	57	10

1/4" Sockets & Accessories

2305M 2305A

12-point Deep Sockets

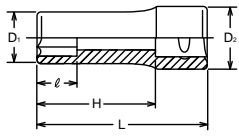

Item Code	Part No.	2305M (mm)	D ₁ (mm)	D ₂ (mm)	ℓ (mm)	H (mm)	L (mm)	(g)	(pcs.)
504300 [^]	KO2305M03	3	5.5	11.2	3	40	50	15	10
504301	KO2305M04	4	6.7	11.2	4	40	50	15	10
504302 [^]	KO2305M05	5	8	11.2	5.5	40	50	17	10
504303 [^]	KO2305M06	6	9.2	11.2	7	40	50	20	10
504304	KO2305M07	7	10.5	11.2	8	40	50	25	10
504305	KO2305M08	8	11.8	11.2	9	40	50	25	10
504306 [^]	KO2305M09	9	13	12	10	40	50	30	10
504307	KO2305M10	10	14.3	12.9	11	39	50	34	10
504308	KO2305M11	11	15.5	14.3	12	39	50	43	10
504309	KO2305M12	12	16.8	15.5	13	39	50	50	10
504310	KO2305M13	13	18	16.4	14	39	50	52	10
504311	KO2305M14	14	19.3	17.9	16	38	50	57	10

Item Code	Part No.	2305A (inch)	D ₁ (mm)	D ₂ (mm)	ℓ (mm)	H (mm)	L (mm)	(g)	(pcs.)
504289	KO2305A04	1/8	5.7	11.2	3.5	40	50	15	10
504290	KO2305A06	3/16	7.8	11.2	5.5	40	50	17	10
504291	KO2305A07	7/32	8.5	11.2	6	40	50	17	10
504292	KO2305A08	1/4	9.8	11.2	7	40	50	25	10
504293	KO2305A09	9/32	10.5	11.2	8	40	50	25	10
504294	KO2305A10	5/16	11.8	11.2	9	40	50	25	10
504295	KO2305A11	11/32	12.5	11.7	10	40	50	30	10
504296	KO2305A12	3/8	13.7	12.5	11	40	50	34	10
504297	KO2305A14	7/16	15.5	14.3	12	39	50	43	10
504298	KO2305A16	1/2	18	16.4	14	39	50	52	10
504299	KO2305A18	9/16	19.3	17.9	16	38	50	57	10

2350M Nut Grip Deep Sockets Nut Grip[®]

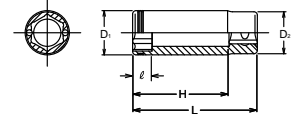

Item Code	Part No.	2350M (mm)	D ₁ (mm)	D ₂ (mm)	ℓ (mm)	H (mm)	L (mm)	(g)	(pcs.)
806781 [^]	KO2350M08	8	12.3	11.2	5	40	50	30	10
806778 [^]	KO2350M10	10	14.2	12.9	6	39	50	35	10
806779 [^]	KO2350M12	12	17.3	16	7	39	50	55	10
806780 [^]	KO2350M14	14	19.9	18	8.5	38	50	70	10

RS2350M/4 Socket Set on Rail



Item Code	Part No.	Socket Sets	(g)
807033 [^]	KORS2350M/4	RS2350M: 4 Pieces Set/Rail 150mm 8, 10, 12, 14	220

RS2300M/11 Deep Socket Set on Rail

RS2305M/11



Item Code	Part No.	Socket Sets	(g)
505549	KORS2300M/11	RS2300M: 11 Pieces Set/Rail 200mm 4, 5, 6, 7, 8, 9, 10, 11, 12, 13, 14	437
505552	KORS2305M/11	RS2305M: 11 Pieces Set/Rail 200mm 4, 5, 6, 7, 8, 9, 10, 11, 12, 13, 14	437

RS2300A/9 Socket Set on Rail

RS2305A/9



Item Code	Part No.	Socket Sets	(g)
505548	KORS2300A/9	RS2300A: 9 Pieces Set/Rail 150mm 3/16, 7/32, 1/4, 9/32, 5/16, 11/32, 3/8, 7/16, 1/2"	296
505551	KORS2305A/9	RS2305A: 9 Pieces Set/Rail 150mm 3/16, 7/32, 1/4, 9/32, 5/16, 11/32, 3/8, 7/16, 1/2"	296

2000-28 (PH) Phillips Bit Sockets

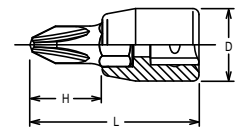

Item Code	Part No.	2000.28 (PH)	D (mm)	H (mm)	L (mm)	(g)	(pcs.)
504233 [^]	KO2000/1	1	11.9	12	28	10	10
504234 [^]	KO2000/2	2	11.9	12	28	11	10
504235 [^]	KO2000/3	3	11.9	12	28	12	10
806751 [^]	KO2000/4	4	13.1	11	28	14	10

2000-28 (PZ) PZ Bit Sockets

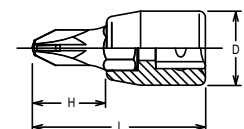

Item Code	Part No.	2000.28 (PZ)	D (mm)	H (mm)	L (mm)	(g)	(pcs.)
806753 [^]	KO2000PZ/1	PZ1	11.9	12	28	10	10
806754 [^]	KO2000PZ/2	PZ2	11.9	12	28	11	10
806755 [^]	KO2000PZ/3	PZ3	11.9	12	28	12	10

Z-SERIES

HAND SOCKETS

SCREWDRIVERS

IMPACT

ACCESSORIES

AUTOMOTIVE

RENEWAL KITS

1/4" Sockets & Accessories

TORX® (T)		T8	T9	T10	T15	T20	T25	T27	T30	T40	T45	T50	T55	T60	T70	T80	T90	T100
	T S (ref. mm)	2.30	2.48	2.72	3.26	3.84	4.40	4.96	5.49	6.60	7.77	8.79	11.17	13.20	15.49	17.51	19.88	22.09

2005-25

 Slotted Bit Sockets

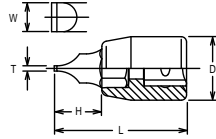

Item Code	Part No.	2005.25	T×W (mm)	D (mm)	H (mm)	L (mm)	(g)	(pcs.)
806757 [^]	KO200503	3	0.5 × 3	11.9	9	25	9	10
504236 [^]	KO200504	4	0.8 × 4	11.9	9	25	10	10
504237 [^]	KO200505	5	1.0 × 5.5	11.9	9	25	10	10
504238 [^]	KO200506	6	1.2 × 6.5	13.1	9	25	11	10
504239 [^]	KO200508	8	1.2 × 8	13.1	9	25	12	10
511082 [^]	KO200509	9	1.6 × 8	13.1	9	25	12	10
806756 [^]	KO200510	10	1.6 × 10	14.3	9	25	13	10

2025-28 (T)

 TORX® Bit Sockets

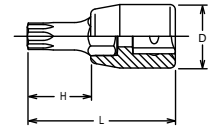

Item Code	Part No.	2025.28 (T)	D (mm)	H (mm)	L (mm)	(g)	(pcs.)
505862 [^]	KO2025T10	T10	11.9	12	28	10	10
505863 [^]	KO2025T15	T15	11.9	12	28	10	10
505864 [^]	KO2025T20	T20	11.9	12	28	11	10
505865 [^]	KO2025T25	T25	11.9	12	28	11	10
900051 [^]	KO2025T27	T27	11.9	12	28	12	10
805315 [^]	KO2025T30	T30	11.9	12	28	12	10
805316 [^]	KO2025T40	T40	11.9	12	28	13	10

2010M-25

 Inhex Bit Sockets

2010A-25

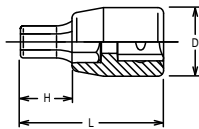

Item Code	Part No.	2010M.25 (mm)	D (mm)	H (mm)	L (mm)	(g)	(pcs.)
504240	KO2010M03	3	11.9	9	25	9	10
504241	KO2010M04	4	11.9	9	25	9	10
504242	KO2010M05	5	11.9	9	25	10	10
504243	KO2010M06	6	11.9	9	25	12	10
504244	KO2010M07	7	13.1	8	25	12	10
504245	KO2010M08	8	13.1	8	25	14	10
504246	KO2010M10	10	14.3	8	25	17	10

Item Code	Part No.	2010A.25 (inch)	D (mm)	H (mm)	L (mm)	(g)	(pcs.)
505851 [^]	KO2010A04	1/8	11.9	9	25	9	10
505852 [^]	KO2010A05	5/32	11.9	9	25	9	10
505853 [^]	KO2010A06	3/16	11.9	9	25	10	10
505854 [^]	KO2010A07	7/32	11.9	9	25	11	10
505855 [^]	KO2010A08	1/4	11.9	9	25	12	10
505856 [^]	KO2010A09	9/32	13.1	8	25	12	10
505857 [^]	KO2010A10	5/16	13.1	8	25	14	10

RS2010M/7-L25

 Inhex Socket Set on Rail

RS2010M/7L100



RS2010A/8-L25





Item Code	Part No.	Socket Sets	(g)
505545	KORS2010M/7-L25	RS2010M.25: 7 Piece Set/Rail 150mm 3, 4, 5, 6, 7, 8, 10mm	115
505544 [^]	KORS2010M/7L100	RS2010M.100: 7 Piece Set/Rail 150mm 3, 4, 5, 6, 7, 8, 10mm	280
505543	KORS2010A/8-L25	RS2010A.25: 8 Piece Set/Rail 150mm 1/8, 5/32, 3/16, 7/32, 1/4, 9/32, 5/16, 3/8"	130

RS2025/7-L28

 TORX® Socket Set on Rail



Item Code	Part No.	Torx® Socket Sets	(g)
505547	KORS2025/7-L28	RS2025.28: 7 Piece Set/Rail 150mm T10, T15, T20, T25, T27, T30, T40	119

2025-28 (TH)

 Tamper-Resistant TORX® Bit Sockets 

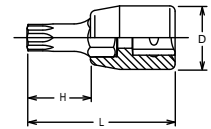

Item Code	Part No.	2025.28 (TH)	D (mm)	H (mm)	L (mm)	(g)	(pcs.)
505866 [^]	KO2025-28TH10	T10H	11.9	12	28	10	10
505858 [^]	KO2025-28TH15	T15H	11.9	12	28	10	10
505859 [^]	KO2025-28TH20	T20H	11.9	12	28	11	10
505860 [^]	KO2025-28TH25	T25H	11.9	12	28	11	10
505861 [^]	KO2025-28TH27	T27H	11.9	12	28	12	10

 This item can be loaded to torque values that may cause breakage. In the interest of your own safety always apply load evenly and progressively to avoid breakage and possible injury.

1/4" Sockets & Accessories

Z-SERIES

HAND SOCKETS

2753PS

Reversible Ratchet Short



* Renewal Kits → 2753RK

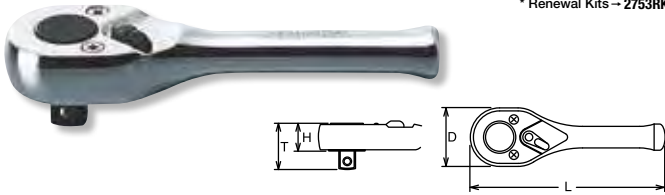

Item Code	Part No.	D (mm)	T (mm)	H (mm)	L (mm)	(g)	(pcs.)
504410	KO2753PS	22	18.7	11.4	75	55	5

2753NB

Reversible Ratchet with Quick Release Button



* Renewal Kits → 2753BRK



2753PB

Reversible Ratchet with Quick Release Button



* Renewal Kits → 2753BRK



SCREWDRIVERS

2753N

Reversible Ratchet



* Renewal Kits → 2753RK



2753P

Reversible Ratchet



* Renewal Kits → 2753RK



2753J

Reversible Ratchet



* Renewal Kits → 2753RK

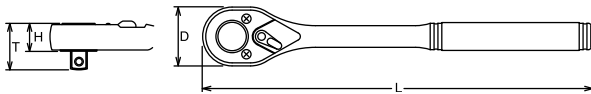

Item Code	Part No.	D (mm)	T (mm)	H (mm)	L (mm)	(g)	(pcs.)
504406	KO2753N	22	18.7	11.4	115	90	10
504407	KO2753P	22	18.7	11.4	115	87	10
504404^	KO2753J	22	18.7	11.4	115	77	5

IMPACT

ACCESSORIES

AUTOMOTIVE

RENEWAL KITS

2753P-160

Reversible Ratchet Long



* Renewal Kits → 2753RK

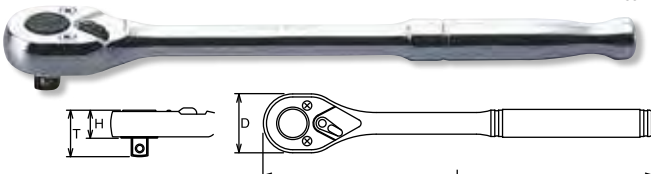

Item Code	Part No.	D (mm)	T (mm)	H (mm)	L (mm)	(g)	(pcs.)
504408	KO2753P160	22	18.7	11.4	160	107	5

2753JB

Reversible Ratchet with Quick Release Button



* Renewal Kits → 2753BRK

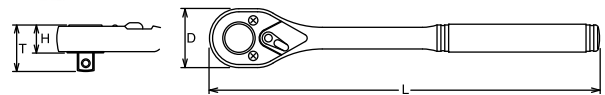

Item Code	Part No.	D (mm)	T (mm)	H (mm)	L (mm)	(g)	(pcs.)
806802	KO2753NB	22	18.7	11.4	115	90	10
504409	KO2753PB	22	18.7	11.4	115	87	10
504405^	KO2753JB	22	18.7	11.4	115	77	5

⚠ Reversible Ratchet with quick release button has less strength compared with normal ratchet due to the technical design. Make sure to use the ratchet correctly.



S.O.D.H-System®

Two dogs are located in the ratchet body so that the dogs and springs are held securely in place while allowing the reversing lever and dog to switch smoothly.

The torque load on the gear is transmitted vertically to the dog, and in turn, down the ratchet handle. This mechanism locks gears tightly in place while torque is being applied, thus avoiding any gear slippage.

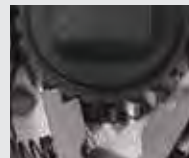

Two-Step Dog

Two flats hold two teeth of the ratchet gear, thus increasing the maximum torque load of the ratchet compared with a single-step system.

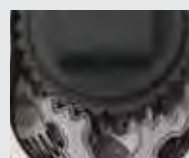

Three-Step Dog

Two dogs are set in the same axis, and the three teeth hold the ratchet gear.

The enlarged contact area produces about 10% higher torque value and the S.O.D.H-System provides smooth and light movements.

1/4" Sockets & Accessories

2774PS Flexible Ratchet, Reversible



* Renewal Kits → 2753RK



2774JS Flexible Ratchet, Reversible



* Renewal Kits → 2753RK

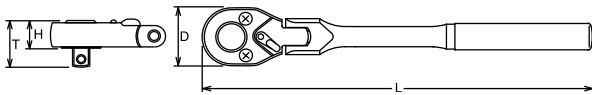

Item Code	Part No.	D (mm)	T (mm)	H (mm)	L (mm)	(g)	(pcs.)
806813	KO2774PS	22	18.7	11.4	116	110	5
504437^	KO2774JS	22	18.7	11.4	116	113	5

2774N Flexible Ratchet, Reversible



* Renewal Kits → 2753RK



2774P Flexible Ratchet, Reversible



* Renewal Kits → 2753RK



2774J Flexible Ratchet, Reversible



* Renewal Kits → 2753RK

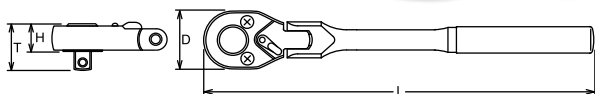

Item Code	Part No.	D (mm)	T (mm)	H (mm)	L (mm)	(g)	(pcs.)
806812	KO2774N	22	18.7	11.4	161	130	2
504439	KO2774P	22	18.7	11.4	161	126	2
504436^	KO2774J	22	18.7	11.4	161	130	2

2755 Ratchet Adaptor



* Renewal Kits → 2755RK

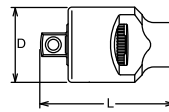

Item Code	Part No.	D (mm)	L (mm)	(g)	(pcs.)
504412	KO2755	26	40	80	10

2756 Quick Spinner



Item Code	Part No.	D (mm)	L (mm)	(g)	(pcs.)
504414^	KO2756	22	20	19	10

2762 Flexible Extension Bar

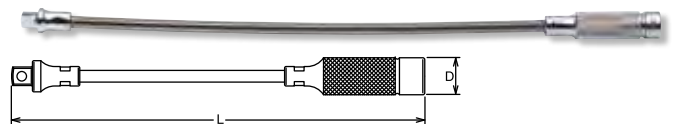

Item Code	Part No.	D (mm)	L (mm)	(g)	(pcs.)
504422	KO2762	13	300	90	2

2760 Extension Bars

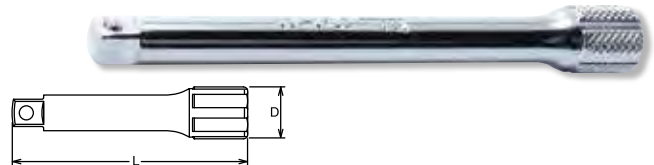

Item Code	Part No.	2760	D (mm)	L (mm)	(g)	(pcs.)
806804^	KO2760028	28	12.3	28	14	10
504415	KO2760050	50	12.3	50	23	10
806806^	KO2760075	75	12.3	75	35	10
504416	KO2760100	100	12.3	100	44	10
504417	KO2760150	150	12.3	150	63	10
806803^	KO2760200	200	12.3	200	83	10
504418	KO2760250	250	12.3	250	103	10
504419^	KO2760300	300	12.3	300	122	2
806805^	KO2760350	350	12.3	350	145	2
504420	KO2760400	400	12.3	400	160	2
504421^	KO2760600	600	12.3	600	240	2

PK2760/6 Extension Bar Set



PLASTIC TRAY

Item Code	Part No.	Extension Bars	(g)
505534	KOPK2760/6	PK2760: 6 Piece Set 2760 Extension Bars 28, 50, 100, 150, 200, 250	430

1/4" Sockets & Accessories

Z-SERIES

2763 Wobble-Fix Extension Bars



! The Wobble-Fix Extension Bar has less strength than normal extension bar due to its specific design with a reduced square drive. Make sure to use it correctly.

Item Code	Part No.	D (mm)	L (mm)	(g)	(pcs.)
504423	KO2763028	12.3	28	14	10
504424	KO2763050	12.3	50	23	10
504425 [^]	KO2763075	12.3	75	33	10
504426	KO2763100	12.3	100	43	10
511181	KO2763150	12.3	150	62	10
511182	KO2763200	12.3	200	80	10
511183	KO2763250	12.3	250	100	10

HAND SOCKETS

SCREWDRIVERS

PK2763/6 Wobble Extension Set



PLASTIC TRAY

Item Code	Part No.	Extension Bars	(g)
505535	KOPK2763/6	PK2763. 6 Piece Set 2763 Wobble-Fix Extension Bar 28, 50, 100, 150, 200, 250	420

IMPACT

ACCESSORIES

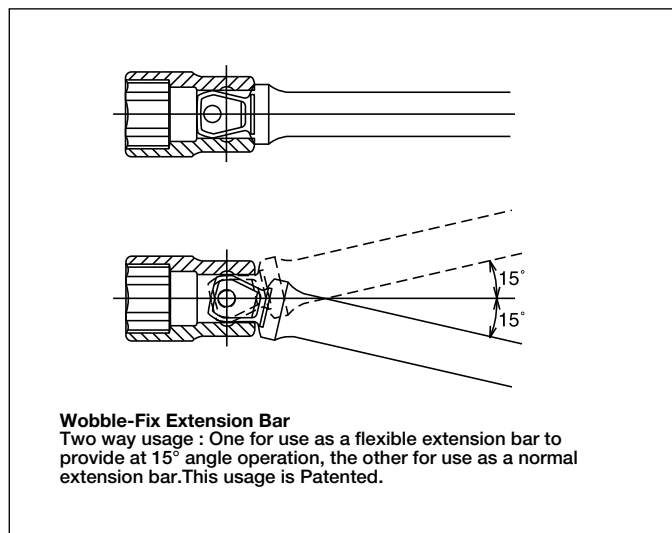

AUTOMOTIVE

RENEWAL KITS

2768N Hinge Handle

* Renewal Kits → 2768RK



2768P Hinge Handle

* Renewal Kits → 2768RK



2768J Hinge Handle

* Renewal Kits → 2768RK

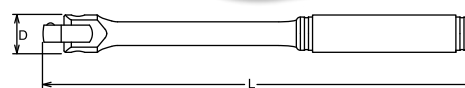

Item Code	Part No.	D (mm)	L (mm)	(g)	(pcs.)
504427	KO2768N	14	130	86	10
504428	KO2768P	14	130	70	10
806810	KO2768J	14	130	73	5

2769N150 Spin Type Handle

Spin Type Handle

2769N220

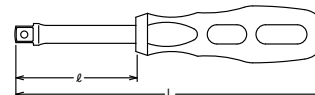

Item Code	Part No.	ℓ (mm)	L (mm)	(g)	(pcs.)
504430 [^]	KO2769N150	50	150	68	2
806811 [^]	KO2769N220	120	220	100	2

2769NWF150 Spin Type Handle(Wobble-Fix)

Spin Type Handle(Wobble-Fix)

2769NWF220

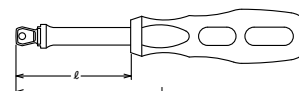

Item Code	Part No.	ℓ (mm)	L (mm)	(g)	(pcs.)
504431	KO2769NWF150	50	150	68	2
504432	KO2769NWF220	120	220	100	2

! Plastic or rubber handles are not intended to act as insulation.

1/4" Sockets & Accessories

2769F Spin Type Handle

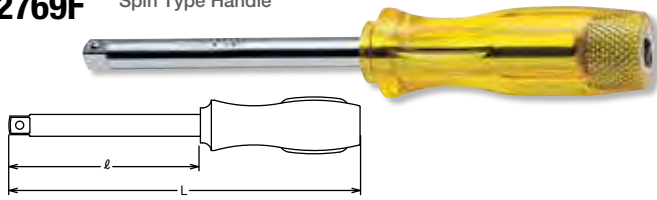

Item Code	Part No.	l (mm)	L (mm)	(g)	(pcs.)
504429	KO2769F	78	150	90	5

2233A Adaptor



Item Code	Part No.	(sq.)	(sq.)	L (mm)	(g)	(pcs.)
504250	KO2233A	1/4"	3/8"	22	16	10

2770 Universal Joint



2771 Universal Joint

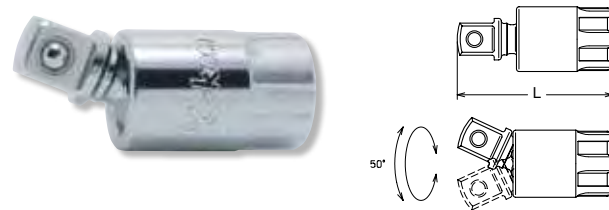

Item Code	Part No.	L (mm)	(g)	(pcs.)
504433	KO2770	33	20	10
804414	KO2771	31	20	10

2780 Speed Handle

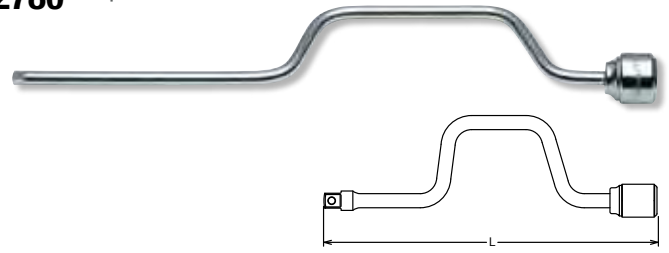

Item Code	Part No.	L (mm)	(g)	(pcs.)
504440	KO2780	350	250	1

2785 T-Handle

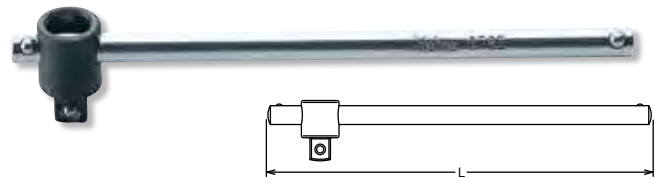

Item Code	Part No.	L (mm)	(g)	(pcs.)
504441	KO2785	115	36	10

Z-SERIES

HAND SOCKETS

SCREWDRIVERS

IMPACT

ACCESSORIES

AUTOMOTIVE

RENEWAL KITS

1/4" Sockets & Accessories

Z-SERIES

HAND SOCKETS

SCREWDRIVERS

IMPACT

ACCESSORIES

AUTOMOTIVE

RENEWAL KITS

2201AM Socket Set



25 Piece Set
METAL CASE:W240xH100xT32mm (g) = 870

Item Code	Part No.	Sockets	Accessories
504248	KO2201AM	 2400M 6-pt. Sockets 4, 5, 5.5, 6, 7, 8, 9, 10, 11, 12, 13	 2753N 2760-100 2769N-150 2770 2785
		 2400A 6-pt. Sockets 3/16, 7/32, 1/4, 9/32, 5/16, 11/32, 3/8, 7/16, 1/2	

2274M
2274A
2274AD Socket Set



PLASTIC BAG

Item Code	Part No.	Socket Sets	(g)
504261^	KO2274M	2274M: 7 Piece Set 6-pt. Deep Sockets 6, 7, 8, 9, 10, 11, 12	245
504259^	KO2274A	2274A: 7 Piece Set 6-pt. Deep Sockets 1/4, 9/32, 5/16, 11/32, 3/8, 7/16, 1/2"	245
504260^	KO2274AD	2274AD: 7 Piece Set 12-pt. Deep Sockets 1/4, 9/32, 5/16, 11/32, 3/8, 7/16, 1/2"	245

2261M Socket Set



17 Piece Set
METAL CASE:W192xH122xT30mm (g) = 690

Item Code	Part No.	Sockets	Accessories
504257	KO2261M	 2400M 6-pt. Sockets 4, 4.5, 5, 5.5, 6, 7, 8, 9, 10, 11, 12	 2753N 2760-50 2760-150 2768N 2770 2785

2277 Socket Set



21 Piece Set
METAL CASE:W310xH86xT50mm (g) = 1,240

Item Code	Part No.	Sockets	Accessories
504265	KO2277	 2400M 6-pt. Sockets 5.5, 6, 7, 8, 9, 10, 11, 12, 13	 2753N 2763-75 2769N-150
		 2300M 6-pt. Deep Sockets 5.5, 6, 7, 8, 9, 10, 11, 12, 13	

3/8" Sockets & Accessories

3400M 3400A

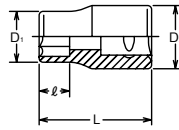

Item Code	Part No.	3400M (mm)	D ₁ (mm)	D ₂ (mm)	ℓ (mm)	L (mm)	(g)	(pcs.)
504653	KO3400M06	6	9.9	17.3	6	26	20	10
504654	KO3400M07	7	10.8	17.3	6.5	26	20	10
504655	KO3400M08	8	12	17.3	7	26	22	10
504656	KO3400M09	9	13.3	17.3	7.5	26	23	10
504657	KO3400M10	10	14.5	17.3	8	26	24	10
504658	KO3400M11	11	15.8	17.3	8.5	26	25	10
504659	KO3400M12	12	16.8	17.3	9	26	25	10
504660	KO3400M13	13	18	17	9.5	26	24	10
504661	KO3400M14	14	19.5	18.5	11	27	31	10
504662	KO3400M15	15	20.8	19.5	11.5	28	39	10
504663	KO3400M16	16	22	20	12	28	42	10
504664	KO3400M17	17	23.3	21.5	12.5	29	51	10
504665	KO3400M18	18	24.5	22.5	13	30	51	10
504666	KO3400M19	19	25.8	23.5	13.5	30	63	10
504667	KO3400M20	20	27	24.5	14	31	75	10
504668	KO3400M21	21	28	26	14.5	32	77	10
504669	KO3400M22	22	29.5	26.5	15	32	82	10
504670	KO3400M23	23	30.8	27.5	15.5	33	95	10
504671	KO3400M24	24	32	28.5	16	34	102	10
806900	KO3400M25	25	33.3	29.5	16.5	34	115	5
806901	KO3400M26	26	34.5	30.5	17	35	129	5

Item Code	Part No.	3400A (inch)	D ₁ (mm)	D ₂ (mm)	ℓ (mm)	L (mm)	(g)	(pcs.)
504639 [^]	KO3400A08	1/4	10.3	17.3	6	26	20	10
504640	KO3400A10	5/16	12	17.3	7	26	22	10
504641 [^]	KO3400A11	11/32	13.3	17.3	7.5	26	23	10
504642	KO3400A12	3/8	13.9	17.3	8	26	23	10
504643	KO3400A14	7/16	15.8	17.3	8.5	26	25	10
504644	KO3400A16	1/2	18	17	9.5	26	24	10
504645	KO3400A18	9/16	19.5	18.5	11	27	31	10
504646	KO3400A19	19/32	20.8	19.5	11.5	28	39	10
504647 [^]	KO3400A20	5/8	22	20	12	28	42	10
504648 [^]	KO3400A22	11/16	24.5	22.5	13	30	51	10
504649 [^]	KO3400A24	3/4	25.8	23.5	13.5	30	63	10
504650 [^]	KO3400A25	25/32	27	24.5	14	31	75	10
504651 [^]	KO3400A26	13/16	28	26	14.5	32	77	10
504652 [^]	KO3400A28	7/8	29.5	26.5	15	32	82	10

RS3400M/12 RS3405M/12



Item Code	Part No.	Socket Sets	(g)
505582	KORS3400M/12	RS3400M: 12 Pieces Set (6 Point) Rail 300mm 8, 9, 10, 11, 12, 13, 14, 15, 16, 17, 18, 19mm	465
505586	KORS3405M/12	RS3405M: 12 Pieces Set (12 Point) Rail 300mm 8, 9, 10, 11, 12, 13, 14, 15, 16, 17, 18, 19mm	465

3405M 3405A

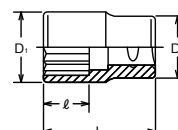

Item Code	Part No.	3405M (mm)	D ₁ (mm)	D ₂ (mm)	ℓ (mm)	L (mm)	(g)	(pcs.)
504686	KO3405M06	6	9.9	17.3	6	26	20	10
504687	KO3405M07	7	10.8	17.3	6.5	26	20	10
504688	KO3405M08	8	12	17.3	7	26	22	10
504689	KO3405M09	9	13.3	17.3	7.5	26	23	10
504690	KO3405M10	10	14.5	17.3	8	26	24	10
504691	KO3405M11	11	15.8	17.3	8.5	26	25	10
504692	KO3405M12	12	16.8	17.3	9	26	25	10
504693	KO3405M13	13	18	17	9.5	26	24	10
504694	KO3405M14	14	19.5	18.5	11	27	31	10
504695	KO3405M15	15	20.8	19.5	11.5	28	39	10
504696	KO3405M16	16	22	20	12	28	42	10
504697	KO3405M17	17	23.3	21.5	12.5	29	51	10
504698	KO3405M18	18	24.5	22.5	13	30	51	10
504699	KO3405M19	19	25.8	23.5	13.5	30	63	10
504700	KO3405M20	20	27	24.5	14	31	75	10
504701	KO3405M21	21	28	26	14.5	32	77	10
504702	KO3405M22	22	29.5	26.5	15	32	82	10
504703	KO3405M23	23	30.8	27.5	15.5	33	95	10
504704	KO3405M24	24	32	28.5	16	34	102	10
806906	KO3405M25	25	33.3	29.5	16.5	34	115	5
806907	KO3405M26	26	34.5	30.5	17	35	129	5

Item Code	Part No.	3405A (inch)	D ₁ (mm)	D ₂ (mm)	ℓ (mm)	L (mm)	(g)	(pcs.)
504672	KO3405A08	1/4	10.3	17.3	6	26	20	10
504673	KO3405A10	5/16	12	17.3	7	26	22	10
504674	KO3405A11	11/32	13.3	17.3	7.5	26	23	10
504675	KO3405A12	3/8	13.9	17.3	8	26	23	10
504676	KO3405A14	7/16	15.8	17.3	8.5	26	25	10
504677	KO3405A16	1/2	18	17	9.5	26	24	10
504678	KO3405A18	9/16	19.5	18.5	11	27	31	10
504679	KO3405A19	19/32	20.8	19.5	11.5	28	39	10
504680	KO3405A20	5/8	22	20	12	28	42	10
504681	KO3405A22	11/16	24.5	22.5	13	30	51	10
504682	KO3405A24	3/4	25.8	23.5	13.5	30	63	10
504683	KO3405A25	25/32	27	24.5	14	31	75	10
504684	KO3405A26	13/16	28	26	14.5	32	77	10
504685	KO3405A28	7/8	29.5	26.5	15	32	82	10

RS3400A/9 RS3405A/9



Item Code	Part No.	Socket Sets	(g)
505581	KORS3400A/9	RS3400A: 9 Pieces Set/Rail 200mm (6 Point) 1/4, 5/16, 3/8, 7/16, 1/2, 9/16, 5/8, 11/16, 3/4"	333
505585	KORS3405A/9	RS3405A: 9 Pieces Set/Rail 200mm (12 Point) 1/4, 5/16, 3/8, 7/16, 1/2, 9/16, 5/8, 11/16, 3/4"	333

FLAT DRIVE®

Flat drive is designed to guarantee a flat surface contact between the socket and the bolt/nut. The flat contact reduces wear and allows to transmit a higher torque value. The flat drive system is also used for the square drive end as well as the hexagonal or bi-hexagonal openings of the socket.

3/8" Sockets & Accessories

3405W 12-point Whitworth Sockets

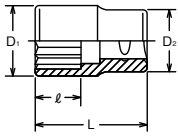

Item Code	Part No.	3405W (W)	D ₁ (mm)	D ₂ (mm)	ℓ (mm)	L (mm)	(g)	(pcs.)
504705	KO3405W04	1/8	13.3	17.3	7.5	26	22	10
504706	KO3405W06	3/16	15.8	17.3	8.5	26	25	10
504707	KO3405W08	1/4	18	17	9.5	26	24	10
504708	KO3405W10	5/16	20.8	19.5	11.5	28	39	10
504709	KO3405W12	3/8	24.5	22.5	13	30	51	10
504710	KO3405W14	7/16	28	26	14.5	32	81	10
504711	KO3405W16	1/2	30.8	27.5	15.5	33	103	10

3425 TORX® Sockets

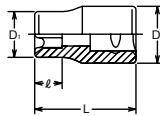

Item Code	Part No.	3425 (E)	D ₁ (mm)	D ₂ (mm)	ℓ (mm)	L (mm)	(g)	(pcs.)
504717 [^]	KO3425E4	E 4	5.6	17.3	4.6	26	18	10
504718 [^]	KO3425E5	E 5	7	17.3	5.2	26	20	10
504719 [^]	KO3425E6	E 6	8.3	17.3	5.4	26	21	10
504720 [^]	KO3425E7	E 7	8.9	17.3	6.6	26	22	10
504721 [^]	KO3425E8	E 8	9.9	17.3	7	26	23	10
504712	KO3425E10	E10	12	17.3	8.2	26	24	10
504713 [^]	KO3425E11	E11	13.3	17.3	8.7	26	25	10
504714	KO3425E12	E12	14.5	17.3	9.3	26	26	10
504715 [^]	KO3425E14	E14	15.8	17.3	10.6	26	27	10
504716 [^]	KO3425E16	E16	18	17	11.8	26	27	10

RS3425/9 Socket Set on Rail



Item Code	Part No.	Torx Socket Set	(g)
505588	KORS3425/9	RS3425: 9 Pieces Set/Rail 200mm E4, E5, E6, E7, E8, E10, E12, E14, E16	239

3450M Nut Grip Sockets Nut Grip®

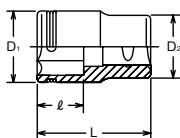

Item Code	Part No.	3450M (mm)	D ₁ (mm)	D ₂ (mm)	ℓ (mm)	L (mm)	(g)	(pcs.)
806915 [^]	KO3450M08	8	12	17.3	5	26	21	10
806908 [^]	KO3450M10	10	14.5	17.3	6	26	24	10
806909 [^]	KO3450M11	11	15.8	17.3	6.5	26	26	10
806910 [^]	KO3450M12	12	16.8	17.3	7	26	26	10
806911 [^]	KO3450M13	13	18	17	8	26	28	10
806912 [^]	KO3450M14	14	19.5	18.5	8.5	27	34	10
806913 [^]	KO3450M17	17	23.3	21.5	9.5	28	62	10
806914 [^]	KO3450M19	19	25.8	23.3	11.5	29	66	10

RS3450M/8 Nut Grip® Socket Set on Rail



Item Code	Part No.	Nut Grip® Socket Set	(g)
505593 [^]	KORS3450M/8	RS3450M: 8 Pieces Set/Rail 200mm 8, 10, 11, 12, 13, 14, 17, 19	310

NUT GRIP®

Twin balls at the 6-point opening hold the bolt/nut tightly for safe and reliable work.

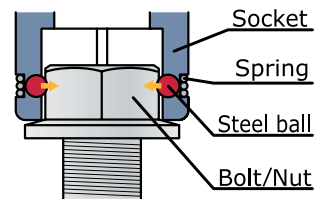

3300M 3300A 6-point Deep Sockets

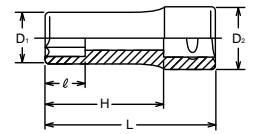

Item Code	Part No.	3300M (mm)	D ₁ (mm)	D ₂ (mm)	ℓ (mm)	H (mm)	L (mm)	(g)	(pcs.)
504577	KO3300M06	6	9.9	17.3	7	41.5	55	37	10
504578	KO3300M07	7	10.6	17.3	8	41.5	55	37	10
504579	KO3300M08	8	12	17.3	9	41.5	55	40	10
504581	KO3300M09	9	13	17.3	10	41.5	55	42	10
504582	KO3300M10	10	14.5	17.3	11	41.5	55	46	10
504584	KO3300M11	11	16	17.2	12	41.5	55	51	10
504585	KO3300M12	12	16.8	17.2	13	41.5	55	52	10
504587	KO3300M13	13	18	17	14	41.5	55	53	10
504588	KO3300M14	14	20	18	16	41.5	55	60	10
504590	KO3300M15	15	21	20	16	40.5	55	74	10
504591	KO3300M16	16	22	20	17	40.5	55	76	10
504592	KO3300M17	17	23.5	22	18	40.5	55	93	10
504593	KO3300M18	18	24.5	23	19	39.5	55	98	10
504594	KO3300M19	19	25	24	20	39.5	55	98	10
805462	KO3300M20	20	26	25	21	49.5	65	126	10
504595	KO3300M21	21	27	26	22	49.5	65	126	10
504596	KO3300M22	22	29	28	23	48.5	65	163	10
504597	KO3300M23	23	30	29	24	48.5	65	168	10
504598	KO3300M24	24	31	30	25	47.5	65	191	10
806872	KO3300M25	25	33	30	26	47.5	65	199	10
806873	KO3300M26	26	34	31	27	47.5	65	209	10
806874	KO3300M27	27	35	32.5	28	47.5	65	218	10

Item Code	Part No.	3300A (inch)	D ₁ (mm)	D ₂ (mm)	ℓ (mm)	H (mm)	L (mm)	(g)	(pcs.)
504560	KO3300A08	1/4	9.9	17.3	7	41.5	55	37	10
504561	KO3300A10	5/16	12	17.3	9	41.5	55	40	10
504562	KO3300A12	3/8	14	17.3	11	41.5	55	46	10
504563	KO3300A14	7/16	16	17.2	12	41.5	55	51	10
504564	KO3300A16	1/2	18	17	14	41.5	55	53	10
504565	KO3300A18	9/16	20	18	16	41.5	55	60	10
504566	KO3300A20	5/8	22	20	17	40.5	55	76	10
504567	KO3300A22	11/16	23.5	22	18	40.5	55	93	10
504568	KO3300A24	3/4	25	24	20	39.5	55	98	10
504569	KO3300A26	13/16	27	26	22	49.5	65	126	10
504570	KO3300A28	7/8	29	28	23	48.5	65	163	10

Z-SERIES

HAND SOCKETS

SCREWDRIVERS

IMPACT

ACCESSORIES

AUTOMOTIVE

RENEWAL KITS

3/8" Sockets & Accessories

3305M
3305A

○ 12-point Deep Sockets

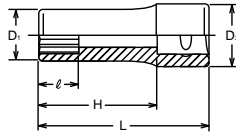

Item Code	Part No.	3305M (mm)	D ₁ (mm)	D ₂ (mm)	ℓ (mm)	H (mm)	L (mm)	(g)	(pcs.)
504613	KO3305M06	6	9.9	17.3	7	41.5	55	37	10
504614	KO3305M07	7	10.6	17.3	8	41.5	55	37	10
504615	KO3305M08	8	12	17.3	9	41.5	55	40	10
504616	KO3305M09	9	13	17.3	10	41.5	55	42	10
504617	KO3305M10	10	14.5	17.3	11	41.5	55	46	10
504618	KO3305M11	11	16	17.2	12	41.5	55	51	10
504619	KO3305M12	12	16.8	17.2	13	41.5	55	52	10
504620	KO3305M13	13	18	17	14	41.5	55	53	10
504621	KO3305M14	14	20	18	16	41.5	55	60	10
504622	KO3305M15	15	21	20	16	40.5	55	74	10
504623	KO3305M16	16	22	20	17	40.5	55	76	10
504624	KO3305M17	17	23.5	22	18	40.5	55	93	10
504625	KO3305M18	18	24.5	23	19	39.5	55	98	10
504626	KO3305M19	19	25	24	20	39.5	55	98	10
504627	KO3305M21	21	27	26	22	49.5	65	126	10
504628	KO3305M22	22	29	28	23	48.5	65	163	10
504629	KO3305M23	23	30	29	24	48.5	65	168	10
504630	KO3305M24	24	31	30	25	47.5	65	191	10
806875	KO3305M25	25	33	30	26	47.5	65	199	10
806876	KO3305M26	26	34	31	27	47.5	65	209	10
806877	KO3305M27	27	35	32.5	28	47.5	65	218	10

Item Code	Part No.	3305A (inch)	D ₁ (mm)	D ₂ (mm)	ℓ (mm)	H (mm)	L (mm)	(g)	(pcs.)
504602	KO3305A08	1/4	9.9	17.3	7	41.5	55	37	10
504603	KO3305A10	5/16	12	17.3	9	41.5	55	40	10
504604	KO3305A12	3/8	14	17.3	11	41.5	55	46	10
504605	KO3305A14	7/16	16	17.2	12	41.5	55	51	10
504606	KO3305A16	1/2	18	17	14	41.5	55	53	10
504607	KO3305A18	9/16	20	18	16	41.5	55	60	10
504608	KO3305A20	5/8	22	20	17	40.5	55	76	10
504609	KO3305A22	11/16	23.5	22	18	40.5	55	93	10
504610	KO3305A24	3/4	25	24	20	39.5	55	98	10
504611	KO3305A26	13/16	27	26	22	49.5	65	126	10
504612	KO3305A28	7/8	29	28	23	48.5	65	163	10
511131	KO3305A30	15/16	31	30	25	47.5	65	191	10
511132	KO3305A32	1	34	31	27	47.5	65	210	10

RS3300M/12
RS3305M/12

○ Socket Set on Rail



Item Code	Part No.	Socket Sets	(g)
505573	KORS3300M/12	RS3300M:12 Pieces Set/Rail 300mm (6 point) 8, 9, 10, 11, 12, 13, 14, 15, 16, 17, 18, 19	878
505578	KORS3305M/12	RS3305M: 12 Pieces Set/Rail 300mm (12 point) 8, 9, 10, 11, 12, 13, 14, 15, 16, 17, 18, 19	878

RS3300A/9
RS3305A/9

○ Socket Set on Rail



Item Code	Part No.	Socket Sets	(g)
505571	KORS3300A/9	RS3300A: 9 Pieces Set/Rail 200mm (6 point) 1/4, 5/16, 3/8, 7/16, 1/2, 9/16, 5/8, 11/16, 3/4"	628
505577	KORS3305A/9	RS3305A: 9 Pieces Set/Rail 200mm (12 point) 1/4, 5/16, 3/8, 7/16, 1/2, 9/16, 5/8, 11/16, 3/4"	628

3300M (L120)

○ 6-point Extra Deep Sockets



3300M-Size(L120) EXTRA DEEP SOCKET

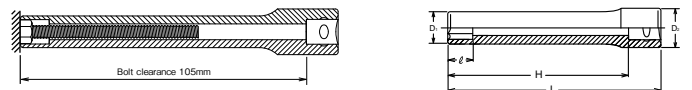

Item Code	Part No.	3300M (L120) (mm)	D ₁ (mm)	D ₂ (mm)	ℓ (mm)	H (mm)	L (mm)	(g)	(pcs.)
504580	KO3300M08L120	8	12	17.3	9	106.5	120	85	10
504583	KO3300M10L120	10	14.5	17.3	11	106.5	120	110	10
504586	KO3300M12L120	12	16.8	17.2	13	106.5	120	116	10
511135 [^]	KO3300M13L120	13	18	17	14	106.5	120	155	5
504589	KO3300M14L120	14	20	18	16	106.5	120	166	5

3300M/4-L120

○ Socket Set



PLASTIC BAG

Item Code	Part No.	4 Piece Socket Set	(g)
504576	KO3300M/4-L120	3300M(L120) 6-point Extra Deep Sockets 8, 10, 12, 14	477

3/8" Sockets & Accessories

Z-SERIES

3325 TORX® Deep Sockets

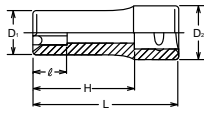

Item Code	Part No.	3325 (E)	D ₁ (mm)	D ₂ (mm)	ℓ (mm)	H (mm)	L (mm)	(g)	(pcs.)
806882 [^]	KO3325E04	E 4	5.6	17.3	4.6	41.5	55	29	10
806883 [^]	KO3325E05	E 5	6.9	17.3	5.2	41.5	55	31	10
806884 [^]	KO3325E06	E 6	7.9	17.3	5.4	41.5	55	33	10
806885 [^]	KO3325E07	E 7	8.9	17.3	6.6	41.5	55	36	10
806886 [^]	KO3325E08	E 8	9.9	17.3	7	41.5	55	39	10
806878 [^]	KO3325E10	E10	11.8	17.3	8.2	41.5	55	43	10
806879 [^]	KO3325E12	E12	14.5	17.2	9.3	41.5	55	53	10
806880 [^]	KO3325E14	E14	15.7	17.2	10.6	41.5	55	57	10
806881 [^]	KO3325E16	E16	18	17	11.8	41.5	55	69	10

HAND SOCKETS

RS3325/9 TORX® Socket Set on Rail



Item Code	Part No.	Torx Deep Socket Set	(g)
505579	KORS3325/9	RS3325: 9 Pieces Set/Rail 200mm E4, E5, E6, E7, E8, E10, E12, E14, E16	420

SCREWDRIVERS

TORX® (E)

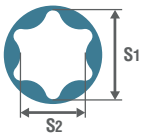

E		E4	E5	E6	E7	E8	E10	E11	E12	E14	E16	E18	E20	E22	E24	E26	E28
S1	(ref. mm)	3.7	4.6	5.6	6.1	7.4	9.3	9.9	11.0	12.8	14.6	16.5	18.3	20.1	22.0	23.7	25.5
S2	(ref. mm)	2.7	3.3	4.0	4.3	5.3	6.8	7.1	7.9	9.2	10.5	11.9	13.2	14.8	15.7	17.5	18.3

IMPACT

3350M Nut Grip Deep Sockets Nut Grip®

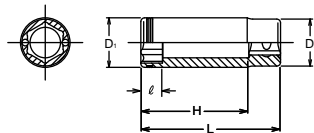

Item Code	Part No.	3350M (mm)	D ₁ (mm)	D ₂ (mm)	ℓ (mm)	H (mm)	L (mm)	(g)	(pcs.)
806895 [^]	KO3350M08	8	12	17.4	5	41.5	55	50	10
806891 [^]	KO3350M10	10	14.5	17.4	6	41.5	55	54	10
806892 [^]	KO3350M12	12	16.8	17.2	7	41.5	55	58	10
806893 [^]	KO3350M13	13	18	17	8	41.5	55	59	10
806894 [^]	KO3350M14	14	19.5	18.5	8.5	41.5	55	71	10

ACCESSORIES

3300FN Flare Nut Sockets

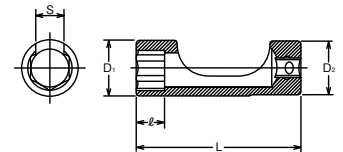

Item Code	Part No.	3300FN (mm)	D ₁ (mm)	D ₂ (mm)	ℓ (mm)	L (mm)	S (mm)	(g)	(pcs.)
806871 [^]	KO3300FN-08	8	14.5	17.3	6	53	6.4	38	10
806869 [^]	KO3300FN-10	10	16.8	17.2	7.5	53	7.2	42	10
806870 [^]	KO3300FN-12	12	20	18	9	53	8.8	50	10
805525 [^]	KO3300FN-14	14	22	20	10.5	62	10.5	66	10
805526 [^]	KO3300FN-17	17	25	24	12.5	80	13	110	10
805527 [^]	KO3300FN-19	19	28	26	14	80	14.5	130	10

AUTOMOTIVE

RS3350M/5 Nut Grip® Deep Socket Set on Rail



Item Code	Part No.	Nut Grip® Deep Socket Set	(g)
505580 [^]	KORS3350M/5	RS3350M: 5 Pieces Set/Rail 150mm 8, 10, 12, 13, 14	322

RENEWAL KITS

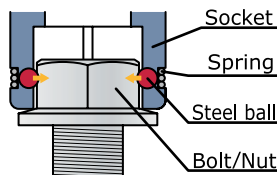

RS3300FN/6 Flare Nut Socket Set on Rail



Item Code	Part No.	Flare Nut Socket Set	(g)
505572 [^]	KORS3300FN/6	RS3300FN: 6 Pieces Set/Rail 150mm 8, 10, 12, 14, 17, 19	450

3/8" Sockets & Accessories

3000-60 (PH) Phillips Bit Sockets

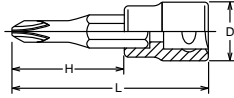

Item Code	Part No.	3000 (PH)	D (mm)	H (mm)	L (mm)	(g)	(pcs.)
806752 [^]	KO3000/1	1	18	33.5	60	49	10
504442 [^]	KO3000/2	2	18	33.5	60	49	10
504443 [^]	KO3000/3	3	18	33.5	60	49	10
504444 [^]	KO3000/4	4	18	33.5	60	50	10

3000-50 (PZ) PZ Bit Sockets

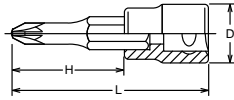

Item Code	Part No.	3000.50 (PZ)	D (mm)	H (mm)	L (mm)	(g)	(pcs.)
806816 [^]	KO3000PZ/1	PZ1	18	23.5	50	50	10
806817 [^]	KO3000PZ/2	PZ2	18	23.5	50	50	10
806818 [^]	KO3000PZ/3	PZ3	18	23.5	50	50	10

3005-60 Slotted Bit Sockets

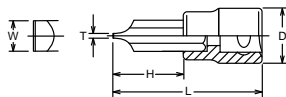

Item Code	Part No.	3005	T×W (mm)	D (mm)	H (mm)	L (mm)	(g)	(pcs.)
504446	KO3005/5	5	1.0 × 5.5	18	33.5	60	47	10
504447	KO3005/8	8	1.2 × 8	18	33.5	60	49	10
504445	KO3005/10	10	1.6 × 10	20	33.5	60	85	10

3010M-38 Inhex Bit Sockets

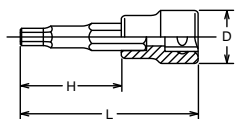

Item Code	Part No.	3010M.38 (mm)	D (mm)	H (mm)	L (mm)	(g)	(pcs.)
806821 [^]	KO3010M3803	3	18	11.5	38	27	10
806822 [^]	KO3010M3804	4	18	11.5	38	28	10
806823 [^]	KO3010M3805	5	18	11.5	38	30	10
806824 [^]	KO3010M3806	6	18	11.5	38	31	10
806825 [^]	KO3010M3807	7	18	11.5	38	32	10
806826 [^]	KO3010M3808	8	18	11.5	38	33	10
806819 [^]	KO3010M3810	10	20	11.5	38	48	10
806820 [^]	KO3010M3812	12	20	11.5	38	60	10

3010M-62 Inhex Bit Sockets

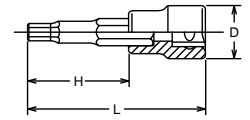

Item Code	Part No.	3010M.62 (mm)	D (mm)	H (mm)	L (mm)	(g)	(pcs.)
504456	KO3010M6203	3	18	35.5	62	43	10
504457	KO3010M6204	4	18	35.5	62	45	10
504458	KO3010M6205	5	18	35.5	62	48	10
504459	KO3010M6206	6	18	35.5	62	49	10
504460 [^]	KO3010M6207	7	18	35.5	62	50	10
504461	KO3010M6208	8	18	35.5	62	62	10
504462 [^]	KO3010M6210	10	20	35.5	62	76	10
504463 [^]	KO3010M6212	12	20	35.5	62	94	10

3010M-100 Inhex Bit Sockets

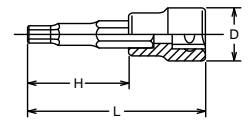

Item Code	Part No.	3010M.100 (mm)	D (mm)	H (mm)	L (mm)	(g)	(pcs.)
504450 [^]	KO3010M100/3	3	18	73.5	100	58	10
504451 [^]	KO3010M100/4	4	18	73.5	100	60	10
504452 [^]	KO3010M100/5	5	18	73.5	100	63	10
504453 [^]	KO3010M100/6	6	18	73.5	100	64	10
504454 [^]	KO3010M100/7	7	18	73.5	100	66	10
504455 [^]	KO3010M100/8	8	18	73.5	100	69	10
504448 [^]	KO3010M100/10	10	20	73.5	100	102	10
504449 [^]	KO3010M100/12	12	20	73.5	100	131	10

RS3010M/8-L38 Socket Set on Rail

RS3010M/8-L62

RS3010M/8-L100



Item Code	Part No.	Inhex Socket Sets	(g)
505560	KORS3010M/8-38	3010M.38: 8 Piece Set/Rail 200mm 3, 4, 5, 6, 7, 8, 10, 12	322
505561	KORS3010M/8-62	3010M.62: 8 Piece Set/Rail 200mm 3, 4, 5, 6, 7, 8, 10, 12	490
505562 [^]	KORS3010M/8-L100	3010M.100: 8 Piece Set/Rail 200mm 3, 4, 5, 6, 7, 8, 10, 12	645

3/8" Sockets & Accessories

3012M-52 • -75
3012A-52

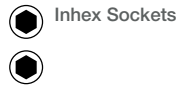

3025-38 • -50 (T) TORX® Bit Sockets

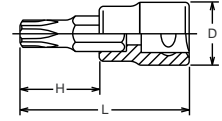
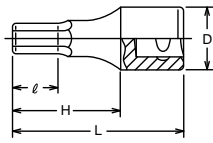

3012M/A are for hand use only.
Do not use with a power or impact wrench.

Item Code	Part No.	3012M.52 (mm)	D (mm)	ℓ (mm)	H (mm)	L (mm)	(g)	(pcs.)
504479	KO3012M5203	3	18	10	34	52	35	10
504480	KO3012M5204	4	18	15.5	34	52	38	10
504481	KO3012M5205	5	18	15.5	34	52	40	10
504482	KO3012M5206	6	18	15.5	34	52	42	10
504483	KO3012M5207	7	18	15.5	34	52	46	10
504484	KO3012M5208	8	18.5	15.5	34	52	50	10
504485	KO3012M5209	9	18.5	15.5	34	52	55	10
504486	KO3012M5210	10	20	15.5	34	52	66	10
504487	KO3012M5211	11	20	15.5	34	52	72	10
504488	KO3012M5212	12	20	15.5	34	52	77	10
504489	KO3012M5213	13	20	15.5	34	52	82	10
504490	KO3012M5214	14	20	15.5	34	52	89	10

Item Code	Part No.	3012A.52 (inch)	D (mm)	ℓ (mm)	H (mm)	L (mm)	(g)	(pcs.)
504467	KO3012A5204	1/8	18	10	34	52	35	10
504468	KO3012A5205	5/32	18	15.5	34	52	38	10
504469	KO3012A5206	3/16	18	15.5	34	52	40	10
504470	KO3012A5207	7/32	18	15.5	34	52	42	10
504471	KO3012A5208	1/4	18	15.5	34	52	44	10
504472	KO3012A5209	9/32	18	15.5	34	52	46	10
504473	KO3012A5210	5/16	18.5	15.5	34	52	50	10
504474^	KO3012A5211	11/32	18.5	15.5	34	52	55	10
504475	KO3012A5212	3/8	20	15.5	34	52	65	10
504476	KO3012A5214	7/16	20	15.5	34	52	72	10
504477^	KO3012A5216	1/2	20	15.5	34	52	82	10
504478^	KO3012A5218	9/16	20	15.5	34	52	89	10

Item Code	Part No.	3012M.75 (mm)	D (mm)	ℓ (mm)	H (mm)	L (mm)	(g)	(pcs.)
806831	KO3012M7503	3	18	10	57	75	41	10
504491	KO3012M7504	4	18	15.5	57	75	43	10
504492	KO3012M7505	5	18	15.5	57	75	48	10
504493	KO3012M7506	6	18	15.5	57	75	53	10
806832	KO3012M7507	7	18	15.5	57	75	58	10
504494	KO3012M7508	8	18.5	15.5	57	75	72	10
806833	KO3012M7509	9	18.5	15.5	57	75	92	10
504495^	KO3012M7510	10	20	15.5	57	75	114	10
806827	KO3012M7511	11	20	15.5	57	75	120	10
806828	KO3012M7512	12	20	15.5	57	75	127	10
806829	KO3012M7513	13	20	15.5	57	75	132	10
806830	KO3012M7514	14	20	15.5	57	75	146	10

RS3012M/8-L52 Socket Set on Rail
RS3012A /8-L52



Item Code	Part No.	Inhex Socket Sets	(g)
505564	KORS3012M52/8	3012M.52: 8 Piece Set/Rail 200mm 3, 4, 5, 6, 7, 8, 10, 12	394
505563	KORS3012A52/8	3012A.52: 8 Piece Set/Rail 200mm 1/8, 5/32, 3/16, 7/32, 1/4, 5/16, 3/8, 1/2"	425

3012M/A are for hand use only.
Do not use with a power or impact wrench.

Item Code	Part No.	3025.38 (T)	D (mm)	H (mm)	L (mm)	(g)	(pcs.)
504496^	KO3025-38T10	T10	18	11.5	38	32	10
504497	KO3025-38T15	T15	18	11.5	38	33	10
504498	KO3025-38T20	T20	18	11.5	38	33	10
504499^	KO3025-38T25	T25	18	11.5	38	33	10
504500	KO3025-38T27	T27	18	11.5	38	33	10
504501	KO3025-38T30	T30	18	11.5	38	33	10
504502	KO3025-38T40	T40	18	11.5	38	34	10
504503	KO3025-38T45	T45	18	11.5	38	37	10

Item Code	Part No.	3025.50 (T)	D (mm)	H (mm)	L (mm)	(g)	(pcs.)
504513^	KO3025-50T10	T10	18	23.5	50	36	10
504514	KO3025-50T15	T15	18	23.5	50	36	10
504515	KO3025-50T20	T20	18	23.5	50	36	10
504516	KO3025-50T25	T25	18	23.5	50	37	10
504517	KO3025-50T27	T27	18	23.5	50	37	10
504518	KO3025-50T30	T30	18	23.5	50	38	10
504519	KO3025-50T40	T40	18	23.5	50	39	10
504520	KO3025-50T45	T45	18	23.5	50	41	10
504521	KO3025-50T50	T50	20	23.5	50	55	10
504522	KO3025-50T55	T55	20	23.5	50	67	10

RS3025/8-L38 TORX® Socket Set on Rail

RS3025/8-L50



Item Code	Part No.	TORX® Socket Set	(g)
807036^	KORS3025/8-L38	3025(T).38: 8 Piece Set/Rail 200mm T10, T15, T20, T25, T27, T30, T40, T45	300
505565	KORS3025/8-L50	3025(T).50: 8 Piece Set/Rail 200mm T10, T15, T20, T25, T27, T30, T40, T45	320

3025-100R (T) TORX® Bit Sockets, Round Shaft



Item Code	Part No.	3025.100R (T)	D (mm)	H (mm)	L (mm)	(g)	(pcs.)
806834^	KO3025-100RT20	T20	18	73.5	100	38	10
806835^	KO3025-100RT25	T25	18	73.5	100	40	10
806836^	KO3025-100RT27	T27	18	73.5	100	42	10
806837^	KO3025-100RT30	T30	18	73.5	100	45	10
806838^	KO3025-100RT40	T40	18	73.5	100	52	10
806839^	KO3025-100RT45	T45	20	73.5	100	73	10
806840^	KO3025-100RT50	T50	20	73.5	100	80	10
806841^	KO3025-100RT55	T55	20	73.5	100	106	10

RS3025/8-L100R TORX® Socket Set on Rail





Item Code	Part No.	Inhex Socket Sets	(g)
505566	KORS3025/8-L100R	3025-100R(T): 8 Piece Set/Rail 200mm T20, T25, T27, T30, T40, T45, T50, T55	490

3/8" Sockets & Accessories

3025-50 (TH) Tamper-Resistant TORX® Bit Sockets



 Tamper Resistant TORX® Bit Sockets have less strength due to special design. Make sure to use it correctly.

Item Code	Part No.	3025.50 (TH)	D (mm)	H (mm)	L (mm)	 (g)	 (pcs.)
504504 [^]	KO3025-50TH10	T10H	18	23.5	50	37	10
504505 [^]	KO3025-50TH15	T15H	18	23.5	50	38	10
504506	KO3025-50TH20	T20H	18	23.5	50	38	10
504507	KO3025-50TH25	T25H	18	23.5	50	38	10
504508	KO3025-50TH27	T27H	18	23.5	50	38	10
504509	KO3025-50TH30	T30H	18	23.5	50	39	10
504510	KO3025-50TH40	T40H	18	23.5	50	40	10
504511	KO3025-50TH45	T45H	18	23.5	50	41	10
504512	KO3025-50TH50	T50H	20	23.5	50	61	10



RS3025/9-HOLE Tamper-Resistant TORX® Socket Set on Rail

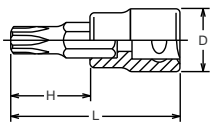

Item Code	Part No.	Tamper Resistant TORX® Socket Set	 (g)
505568	KORS3025/9TP	3025-50(TH): 9 Piece Set/Rail 200mm T10H, T15H, T20H, T25H, T27H, T30H, T40H, T45H, T50H	405

3025-50 (IP) TORXPLUS® Bit Sockets



Item Code	Part No.	3025.50 (IP)	D (mm)	H (mm)	L (mm)	 (g)	 (pcs.)
806842 [^]	KO3025-50IP20	20IP	18	23.5	50	38	10
806843 [^]	KO3025-50IP25	25IP	18	23.5	50	38	10
806844 [^]	KO3025-50IP27	27IP	18	23.5	50	40	10
806845 [^]	KO3025-50IP30	30IP	18	23.5	50	40	10
806846 [^]	KO3025-50IP40	40IP	18	23.5	50	41	10
806847 [^]	KO3025-50IP45	45IP	18	23.5	50	41	10
806848 [^]	KO3025-50IP50	50IP	20	23.5	50	61	10
806849 [^]	KO3025-50IP55	55IP	20	23.5	50	61	10

TORXPLUS® (IP)

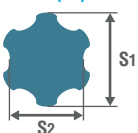

IP	8IP	9IP	10IP	15IP	20IP	25IP	27IP	30IP	40IP	45IP	50IP	55IP	60IP	70IP
S ₁	(ref. mm)	2.3	2.5	2.7	3.3	3.9	4.5	5.0	5.6	6.7	7.9	8.9	11.3	13.3
S ₂	(ref. mm)	1.7	1.8	2.0	2.3	2.8	3.2	3.6	4.0	4.8	5.6	6.2	8.0	9.5

Disclaimer: Every effort has been made to publish the correct details in this brochure. No responsibility will be taken for errors, omissions or changes in product specifications. [^] Special Order Only

3/8" Sockets & Accessories

Z-SERIES

2749N-3/8 Reversible Ratchet ⚠



* Renewal Kits → 2749RK-3/8

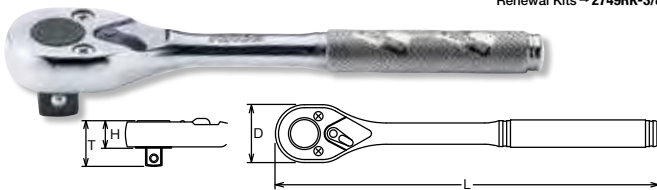

Item Code	Part No.	D (mm)	T (mm)	H (mm)	L (mm)	(g)	(pcs.)
504399	KO2749N-3/8	25	21.9	11.2	125	104	10

⚠ 2749-3/8 series have less strength compared with normal ratchet due to the technical design. Make sure to use the ratchet correctly.

HAND SOCKETS

3749S Reversible Ratchet Short



* Renewal Kits → 3749RK



Item Code	Part No.	D (mm)	T (mm)	H (mm)	L (mm)	(g)	(pcs.)
504751	KO3749S	34	24.8	14.1	110	183	5

3749N Reversible Ratchet



* Renewal Kits → 3749RK

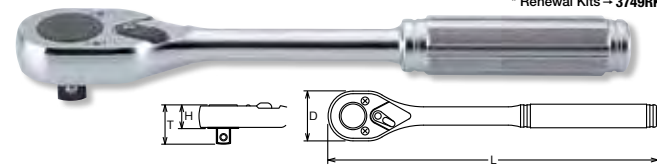

Item Code	Part No.	D (mm)	T (mm)	H (mm)	L (mm)	(g)	(pcs.)
504748	KO3749N	34	24.8	14.1	200	340	1

SCREWDRIVERS

IMPACT

3776N Swivel Head Ratchet



* Renewal Kits → 3752RK



3776P Swivel Head Ratchet



* Renewal Kits → 3752RK



3776J Swivel Head Ratchet



* Renewal Kits → 3752RK

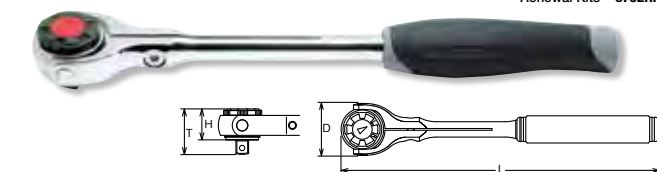

Item Code	Part No.	D (mm)	T (mm)	H (mm)	L (mm)	(g)	(pcs.)
504807^	KO3776N	44	34.3	23.9	280	565	1
504808^	KO3776P	44	34.3	23.9	280	560	1
504806^	KO3776J	44	34.3	23.9	280	510	1

ACCESSORIES

AUTOMOTIVE

RENEWAL KITS



[L/R Marking]

A pointer and L/R markings on the ratchet head indicate the turning direction.

The reduced diameter of the head allows easier access in tight spots.

3753SM

Multi Purpose Ratchet, Reversible



* Renewal Kits → 3753RK



Item Code	Part No.	D (mm)	T (mm)	H (mm)	L (mm)	(g)	(pcs.)
504764	KO3753SM	30.5	26.4	15.7	81	175	5

3753N



* Renewal Kits → 3753RK



3753P



* Renewal Kits → 3753RK



3753J



* Renewal Kits → 3753RK



Item Code	Part No.	D (mm)	T (mm)	H (mm)	L (mm)	(g)	(pcs.)
504758	KO3753N	30.5	26.4	15.7	200	320	1
504760	KO3753P	30.5	26.4	15.7	200	286	1
807008	KO3753J	30.5	26.4	15.7	200	260	1

3753P-250 Reversible Ratchet Long



* Renewal Kits → 3753RK

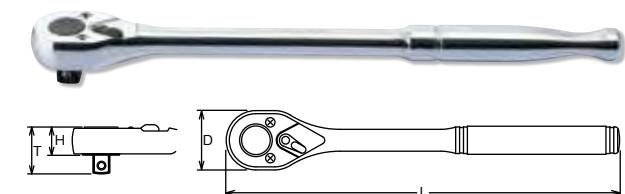

Item Code	Part No.	D (mm)	T (mm)	H (mm)	L (mm)	(g)	(pcs.)
504761	KO3753P250	30.5	26.4	15.7	250	335	1

3/8" Sockets & Accessories

3753SMB Multi Purpose Ratchet with Quick Release Button



* Renewal Kits → 3753BRK

Item Code	Part No.	D (mm)	T (mm)	H (mm)	L (mm)	(g)	(pcs.)
806920	KO3753SMB	30.5	26.4	15.7	81	175	5

 Reversible ratchet with quick release button has less strength compared with normal ratchet due to the technical design. Make sure to use the ratchet correctly.

3753NB Reversible Ratchet with Quick Release Button



* Renewal Kits → 3753BRK

3753PB Reversible Ratchet with Quick Release Button

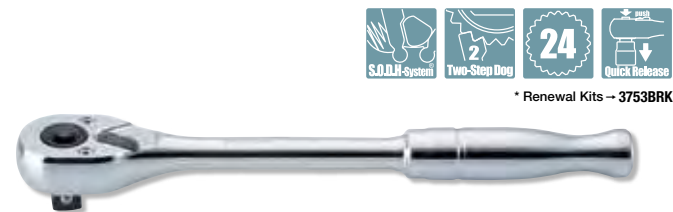

* Renewal Kits → 3753BRK

3753JB Reversible Ratchet with Quick Release Button

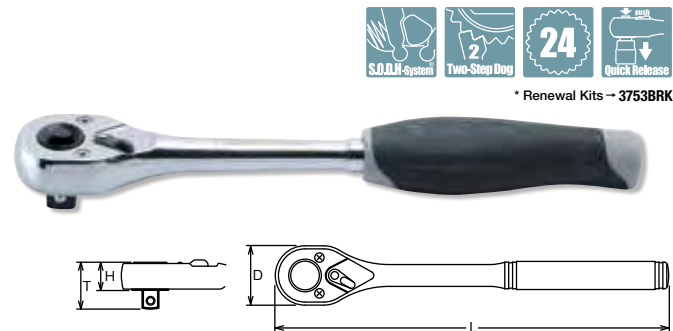

* Renewal Kits → 3753BRK

Item Code	Part No.	D (mm)	T (mm)	H (mm)	L (mm)	(g)	(pcs.)
504759^	KO3753NB	30.5	26.4	15.7	200	320	1
806919	KO3753PB	30.5	26.4	15.7	200	286	1
806918	KO3753JB	30.5	26.4	15.7	200	260	1

 Reversible Ratchet with quick release button has less strength compared with normal ratchet due to the technical design. Make sure to use the ratchet correctly.

2774PS-3/8 Flexible Ratchet, Reversible



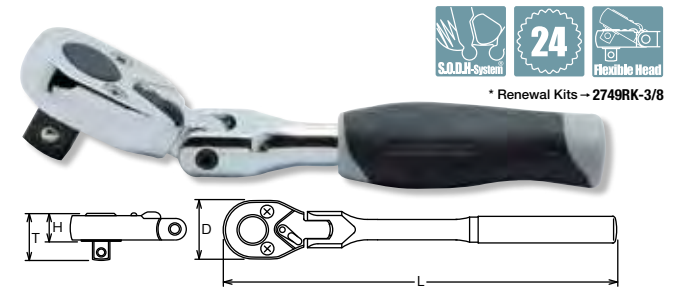

* Renewal Kits → 2749RK-3/8

2774JS-3/8 Flexible Ratchet, Reversible



* Renewal Kits → 2749RK-3/8

Item Code	Part No.	D (mm)	T (mm)	H (mm)	L (mm)	(g)	(pcs.)
505874^	KO2774PS-3/8	25	21.9	11.2	120	133	5
504438^	KO2774JS-3/8	25	21.9	11.2	120	113	5

 2774-3/8 series have less strength compared with normal  ratchet due to the technical design. Make sure to use the ratchet correctly.

3774PS Flexible Ratchet, Reversible

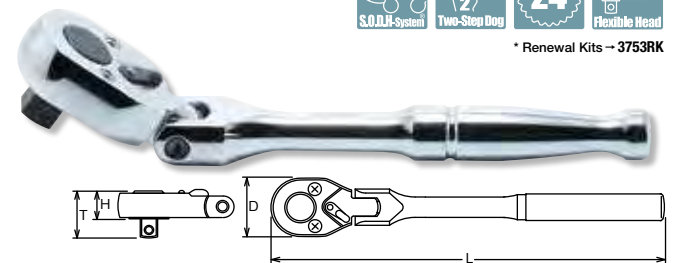

* Renewal Kits → 3753RK

Item Code	Part No.	D (mm)	T (mm)	H (mm)	L (mm)	(g)	(pcs.)
504802	KO3774PS	30.5	26.4	15.7	175	250	2

Reversible Ratchet with Quick Release Button :

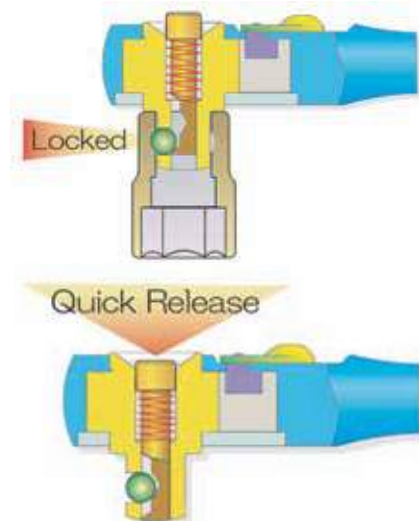

Sockets and accessories are safely locked. By pushing the button the sockets or extension bars are released from the ratchet.

3/8" Sockets & Accessories

Z-SERIES

3774N Flexible Ratchet, Reversible



* Renewal Kits → 3753RK



HAND SOCKETS

3774P Flexible Ratchet, Reversible



* Renewal Kits → 3753RK



SCREWDRIVERS

3774J Flexible Ratchet, Reversible



* Renewal Kits → 3753RK

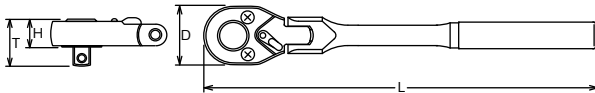

Item Code	Part No.	D (mm)	T (mm)	H (mm)	L (mm)	(g)	(pcs.)
504798	KO3774N	30.5	26.4	15.7	265	378	2
504800	KO3774P	30.5	26.4	15.7	265	378	2
504797	KO3774J	30.5	26.4	15.7	285	367	1

IMPACT

3774NB Flexible Ratchet, Reversible with Quick Release Button



* Renewal Kits → 3753BRK



ACCESSORIES

3774PB Flexible Ratchet, Reversible with Quick Release Button



* Renewal Kits → 3753BRK



AUTOMOTIVE

3774JB Flexible Ratchet, Reversible with Quick Release Button



* Renewal Kits → 3753BRK

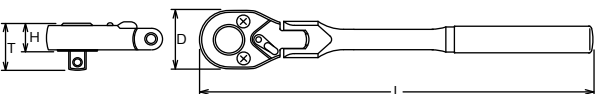

Item Code	Part No.	D (mm)	T (mm)	H (mm)	L (mm)	(g)	(pcs.)
806931	KO3774NB	30.5	26.4	15.7	265	378	2
504801	KO3774PB	30.5	26.4	15.7	265	373	2
806930	KO3774JB	30.5	26.4	15.7	285	367	1

RENEWAL KITS

Reversible Ratchet with quick release button has less strength compared with normal ratchet due to the technical design. Make sure to use the ratchet correctly.

Reversible Ratchet with Quick Release Button :

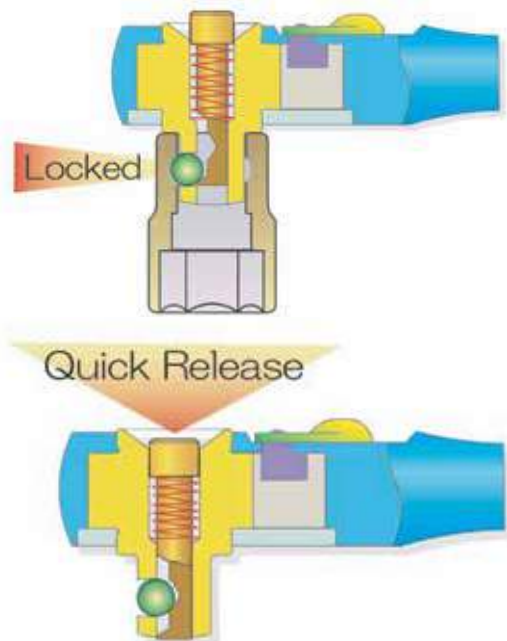

Sockets and accessories are safely locked. By pushing the button the sockets or extension bars are released from the ratchet.

3/8" Sockets & Accessories

3755 Ratchet Adaptor

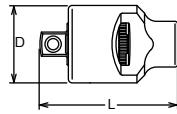

45

* Renewal Kits - 3755RK

Item Code	Part No.	D (mm)	L (mm)	(g)	(pcs.)
504765	KO3755	30.5	55	146	5

3756 Quick Spinner

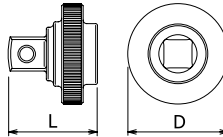

Item Code	Part No.	D (mm)	L (mm)	(g)	(pcs.)
504767^	KO3756	30.5	25.5	47	10

3757 Ratchet Wheel



L/R Marking 45

* Renewal Kits - 3752RK

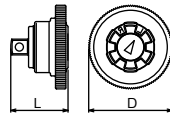

Item Code	Part No.	D (mm)	L (mm)	(g)	(pcs.)
504768^	KO3757	50	35	155	5

3762 Flexible Extension Bar

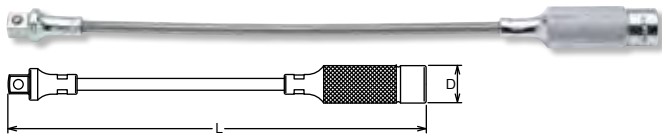

Item Code	Part No.	D (mm)	L (mm)	(g)	(pcs.)
504779	KO3762	19.3	300	178	2

3760 Extension Bars



Item Code	Part No.	D (mm)	L (mm)	(g)	(pcs.)
504770	KO3760032	18	32	27	10
504771	KO3760050	18	50	47	10
504772	KO3760075	18	75	68	10
504774	KO3760125	18	125	106	10
511083^	KO3760150	18	150	125	10
504775	KO3760250	18	250	196	5
806921^	KO3760300	18	300	291	2
504776	KO3760400	18	400	365	1
806922^	KO3760500	18	500	490	1
504777	KO3760600	18	600	538	1
504778	KO3760900	18	900	805	1
504773	KO37601000	18	1000	968	1

PK3760/6 Extension Bar Set



PLASTIC TRAY

Item Code	Part No.	Extension Bars	(g)
505536	KOPK3760/6	3760: 6 Piece Set Extension Bars 32, 50, 75, 125, 150, 250	670

3763 Wobble-Fix Extension Bars

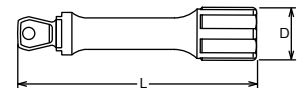

Item Code	Part No.	D (mm)	L (mm)	(g)	(pcs.)
504780	KO3763032	18	32	26	10
504781	KO3763050	18	50	42	10
504782	KO3763075	18	75	57	10
504783	KO3763125	18	125	80	10
504784	KO3763150	18	150	98	10
504785	KO3763250	18	250	144	5
806926^	KO3763300	18	300	170	2

The Wobble-Fix Extension Bar has less strength than normal extension bar due to its specific design with a reduced square drive. Make sure to use it correctly.

3/8" Sockets & Accessories

Z-SERIES

HAND SOCKETS

SCREWDRIVERS

IMPACT

ACCESSORIES

AUTOMOTIVE

RENEWAL KITS

PK3763/6 Wobble-Fix Extension Bar Set



PLASTIC TRAY

Item Code	Part No.	Extension Bars	(g)
505537	KOPK3763/6	3763: 6 Piece Set Wobble-Fix Extension Bars 32, 50, 75, 125, 150, 250	560

Wobble-Fix Extension Bar

Two way usage : one for as a flexible extension bar to provide at 15° angle operation, the other for use as a normal extension bar. This usage is Patented.

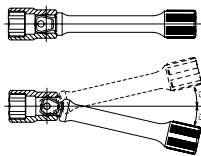

⚠ The Wobble-Fix Extension Bar has less strength than normal extension bar due to it's specific design with a reduced square drive. Make sure to use it correctly.

3768N-175 Hinge Handle



* Renewal Kits → 3768RK



3768N-250 Hinge Handle



* Renewal Kits → 3768RK



3768P-250 Hinge Handle



* Renewal Kits → 3768RK



3768J-250 Hinge Handle



* Renewal Kits → 3768RK

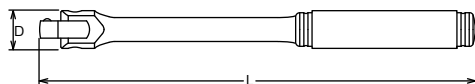

Item Code	Part No.	D (mm)	L (mm)	(g)	(pcs.)
504786	KO3768N175	20.5	175	255	5
504787	KO3768N250	20.5	250	290	5
504788	KO3768P250	20.5	250	275	5
806927	KO3768J250	20.5	250	248	2

3768P-380 Hinge Handle **⚠**

* Renewal Kits → 3768RK

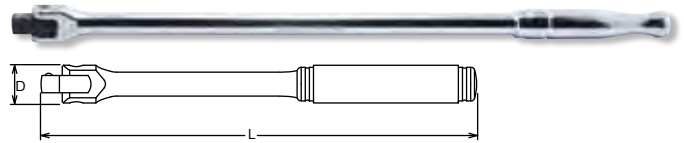

Item Code	Part No.	D (mm)	L (mm)	(g)	(pcs.)
504789	KO3768P380	20.5	380	435	2

⚠ KO3768P380 has a longer handle than standard, and can be loaded to excessive torque value. In the interest of your own safety always apply load evenly and progressively to avoid breakage and possible injury.

3769N-160 Spin Type Handle **⚠**



3769N-230 Spin Type Handle **⚠**

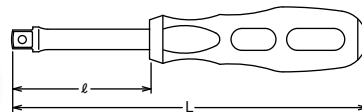

Item Code	Part No.	l (mm)	L (mm)	(g)	(pcs.)
504792^	KO3769N160	50	160	96	2
806928^	KO3769N230	120	230	126	2

⚠ Plastic or rubber handles are not intended to act as insulation.

3769NWF-160 Spin Type Handle Wobble-Fix **⚠**



3769NWF-230 Spin Type Handle Wobble-Fix **⚠**

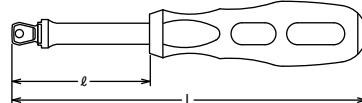

Item Code	Part No.	l (mm)	L (mm)	(g)	(pcs.)
806929^	KO3769NWF160	50	160	96	2
504793^	KO3769NWF230	120	230	126	2

⚠ Plastic or rubber handles are not intended to act as insulation.

3/8" Sockets & Accessories

3770 Universal Joint



3771 Universal Joint



Item Code	Part No.	L (mm)	(g)	(pcs.)
504794	KO3770	50	66	10
504796	KO3771	43	46	10

3780 Speed Handle

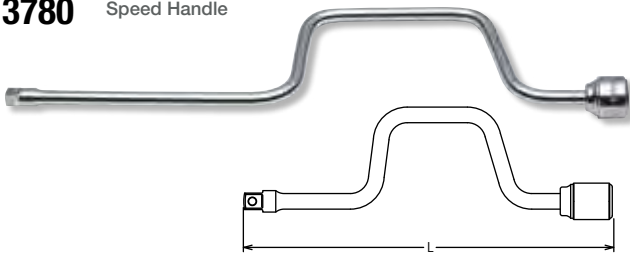

Item Code	Part No.	L (mm)	(g)	(pce.)
504809	KO3780	400	432	1

3785 T-Handle

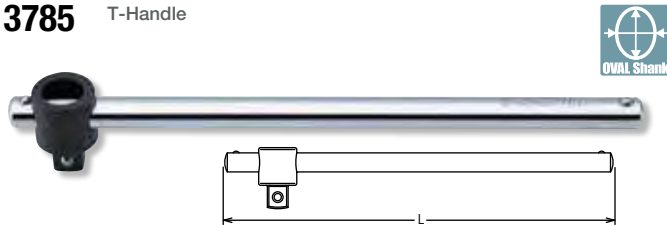

Innovative Oval shaped bar provides higher durability and stops the sliding square part turning around the bar.

Item Code	Part No.	L (mm)	(g)	(pcs.)
504811^	KO3785	200	157	5

3322A Adaptor Warranty 86Nm



Item Code	Part No.	D (mm)	(sq)	L (mm)	(g)	(pcs.)
504636	KO3322A	3/8"	1/4"	24	18	10

⚠ Adapting down from bigger square drive to smaller square drive may lead to excessive torque and possibly cause breakage.

3344A Adaptor



Item Code	Part No.	(sq)	(sq)	L (mm)	(g)	(pcs.)
504638	KO3344A	3/8"	1/2"	30	35	10

⚠ Adapting down from bigger square drive to smaller square drive may lead to excessive torque and possibly cause breakage.

PK2346/6 Adaptor Set



- 2233A (1/4" X 3/8")
- 3322A (3/8" X 1/4") Warranty 86Nm
- 3344A (3/8" X 1/2")
- 4433A (1/2" X 3/8") Warranty 290Nm
- 4466A (1/2" X 3/4")
- 6644A (3/4" X 1/2") Warranty 668Nm

PLASTIC TRAY 6 Piece Set/△=460g

Item Code	Part No.	Adaptors			
505533	KOPK2346/6	1/4" □ → 3/8" □	2233A	3/8" □ → 1/4" □	3322A
		3/8" □ → 1/2" □	3344A	1/2" □ → 3/8" □	4433A-35
		1/2" □ → 3/4" □	4466A	3/4" □ → 1/2" □	6644A

3/8" Sockets & Accessories

Z-SERIES

HAND SOCKETS

SCREWDRIVERS

IMPACT

ACCESSORIES

AUTOMOTIVE

RENEWAL KITS

3200M 3200A

Socket Sets



18 Piece Set
METAL CASE:W415xH120xT50mm Δ = 2,250g

Item Code	Part No.	Sockets	Accessories
504536 [^]	KO3200M	 3400M 6-pt. Sockets 6, 8, 9, 10, 11, 12	3753N
			3760-125
			3760-250
			3768N-250
			3769N-160
		 3405M 12-pt. Sockets 13, 14, 17, 18, 19, 21	3785

18 Piece Set
METAL CASE:W415xH120xT50mm Δ = 2,250g

Item Code	Part No.	Sockets	Accessories
504535 [^]	KO3200A	 3400A 6-pt. Sockets 1/4, 5/16, 3/8, 7/16	3753N
			3760-125
			3760-250
			3768N-250
			3769N-160
		 3405A 12-pt. Sockets 1/2, 9/16, 19/32, 5/8, 11/16, 3/4, 13/16, 7/8	3785

3201AMW

Socket Set



42 Piece Set
METAL CASE:W445xH190xT50mm Δ = 4,700g

Item Code	Part No.	Sockets	Accessories
504537 [^]	KO3201AMW	 3405M 12-pt. Sockets 9, 10, 11, 12, 13, 14, 15, 16, 17, 18, 19, 20, 21, 22mm	3753N
			3760-75
			3760-125
			3760-250
			3768N-250
		 3405A 12-pt. Sockets 5/16, 3/8, 7/16, 1/2, 9/16, 5/8, 11/16, 3/4, 25/32, 13/16, 7/8"	3769N-160
			3770
			3780
			3785
			3344A
		 3405W 12-pt. Sockets 1/8, 3/16, 1/4, 5/16, 3/8, 7/16, 1/2"	

3206M

Socket Set



21 Piece Set
METAL CASE:W395xH90xT50mm Δ (g) = 2,100

Item Code	Part No.	Sockets	Accessories
504540 [^]	KO3206M	 3400M 6-pt. Sockets 6, 7, 8, 9, 10, 11, 12	3753N
			3760-125
			3760-250
			3768N-250
			3785
		 3405M 12-pt. Sockets 13, 14, 15, 16, 17, 18, 19, 21, 22	

3206A

Socket Set



17 Piece Set
METAL CASE:W395xH90xT50mm Δ (g) = 2,000

Item Code	Part No.	Sockets	Accessories
504538 [^]	KO3206A	 3400A 6-pt. Sockets 1/4, 5/16, 11/32, 3/8, 7/16	3753N
			3760-125
			3760-250
			3768N-250
			3785
		 3405A 12-pt. Sockets 1/2, 9/16, 5/8, 11/16, 3/4, 13/16, 7/8	

3206AM

Socket Set



27 Piece Set
METAL CASE:W445xH190xT50mm Δ (g) = 3,500

Item Code	Part No.	Sockets	Accessories	
504539 [^]	KO3206AM	 3405M 12-pt. Sockets 7, 8, 10, 11, 12, 13, 14, 15, 16, 17, 19, 22	3753N	
			3760-125	
			3760-250	
			3768N-250	
			3770	
		 3405A 12-pt. Sockets 3/8, 7/16, 1/2, 9/16, 5/8, 11/16, 3/4, 13/16, 7/8		
			 3300C Spark Plug Socket 20.8	

3/8" Sockets & Accessories

3210M Socket Set



22 Piece Set
METAL CASE:W360xH145xT50mm (g) = 2,900

Item Code	Part No.	Sockets	Accessories
504541^	KO3210M	3400M 6-pt. Sockets 6, 7, 8, 9, 10, 11, 12	3753N 3760-125 3760-250 3768N-250
		3405M 12-pt. Sockets 13, 14, 15, 16, 17, 18, 19, 21, 22	3770 3785

3215M Socket Sets 3215A



PLASTIC BAG

Item Code	Part No.	7 Piece Socket Sets	(g)
504543	KO3215M	3305M 12-pt. Deep Sockets 8, 10, 11, 12, 13, 14, 17	430
504542	KO3215A	3305A 12-pt. Deep Sockets 5/16, 3/8, 7/16, 1/2, 9/16, 5/8, 11/16"	430

3217M Socket Set 3217MS 3217A



METAL CASE

Item Code	Part No.	Sockets	(g)
504546^	KO3217M	3405M 12-pt. Sockets 14 Piece Set 9, 10, 11, 12, 13, 14, 15, 16, 17, 18, 19, 20, 21, 22	850
504547^	KO3217MS	3400M 6-pt. Sockets 14 Piece Set 9, 10, 11, 12, 13, 14, 15, 16, 17, 18, 19, 20, 21, 22	850
504545^	KO3217A	3405A 12-pt. Sockets 13 Piece Set 5/16, 3/8, 7/16, 1/2, 9/16, 19/32, 5/8, 3/4, 25/32, 13/16, 7/8, 1 1/16	790

3220M Socket Set



14 Piece Set
METAL CASE:W415xH120xT50mm (g) = 2,270

Item Code	Part No.	Sockets	Accessories
504548	KO3220M	3405M 12-pt. Sockets 8, 9, 10, 11, 12, 13, 14, 17, 19, 21, 22	3753N 3760-125 3768N-250

3221M Socket Set



18 Piece Set
METAL CASE:W415xH120xT50mm (g) = 2,300

Item Code	Part No.	Sockets	Accessories
504549^	KO3221M	3405M 12-pt. Sockets 6, 8, 9, 10, 11, 12, 13, 14, 17, 19, 21, 22	3753N 3760-125 3760-250 3768N-250 3769N-160 3785

3250M Socket Set



17 Piece Set
METAL CASE:W415xH120xT50mm (g) = 2,200

Item Code	Part No.	Sockets	Accessories
806866^	KO3250M	3400M 6-pt. Sockets 7, 8, 10, 11, 12, 13, 14, 15, 16, 17, 18, 19	3753N 3760-125 3760-250 3770 3785

Z-SERIES

HAND SOCKETS

SCREWDRIVERS

IMPACT

ACCESSORIES

AUTOMOTIVE

RENEWAL KITS

3/8" Sockets & Accessories

Z-SERIES

HAND SOCKETS

SCREWDRIVERS

IMPACT

ACCESSORIES

AUTOMOTIVE

RENEWAL KITS

3275 Socket Set



24 Piece Set
METAL CASE:W400xH147xT50mm Δ = 3,150g

Item Code	Part No.	Sockets	Accessories
504556^	KO3275	 3400M 6-pt. Sockets 6, 7, 8, 9, 10, 11, 12	 3753N 3760-125 3760-250 3768N-250 3770 3756
		 3405M 12-pt. Sockets 13, 14, 15, 16, 17, 18, 19, 21, 22	
		 3300C Spark Plug Sockets 16, 20.8	

3279AM Socket Set



35 Piece Set
METAL CASE:W445xH190xT50mm Δ = 4,200g

Item Code	Part No.	Sockets	Accessories
504559^	KO3279AM	 3405M 12-pt. Sockets 9, 10, 11, 12, 13, 14, 15, 16, 17, 18, 19, 20, 21, 22	 3753N 3760-75 3760-125 3760-250 3768N-250 3769N-160 3770 3785
		 3405A 12-pt. Sockets 5/16, 3/8, 7/16, 1/2, 9/16, 5/8, 11/16, 3/4, 25/32, 13/16, 7/8	
		 3300S Spark Plug Sockets 16, 20.8	

3277 Socket Set





29 Piece Set
METAL CASE:W370xH150xT50mm Δ = 3,240g

Item Code	Part No.	Sockets	Accessories
504558	KO3277	 3400M 6-pt. Sockets 8, 9, 10, 11, 12	 3753N 3760-125 3768N-250
		 3405M 12-pt. Sockets 13, 14, 15, 16, 17, 18, 19, 21	
		 3300M 6-pt. Deep Sockets 8, 9, 10, 11, 12	
		 3305M 12-pt. Deep Sockets 13, 14, 15, 16, 17, 18, 19, 21	

1/2" Sockets & Accessories

Z-SERIES

- RS4400M/10**   Socket Set on Rail
- RS4405M/10**  
- RS4400A/10**  
- RS4405A/10**  





Item Code	Part No.	Socket Sets	 (g)
505610	KORS4400M/10	4400M: 10 Pieces Set/Rail 300mm 10, 11, 12, 13, 14, 15, 17, 19, 21, 22	717
505612	KORS4405M/10	4405M: 10 Pieces Set/Rail 300mm 10, 11, 12, 13, 14, 15, 17, 19, 21, 22	717
505608^	KORS4400A/10	4400A: 10 Pieces Set/Rail 300mm 3/8, 7/16, 1/2, 9/16, 5/8, 11/16, 3/4, 13/16, 7/8, 15/16"	809
505611	KORS4405A/10	4405A: 10 Pieces Set/Rail 300mm 3/8, 7/16, 1/2, 9/16, 5/8, 11/16, 3/4, 13/16, 7/8, 15/16"	809

HAND SOCKETS

SCREWDRIVERS

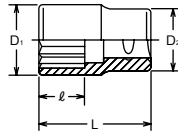
- 4405W**  12-point Whitworth Sockets



Item Code	Part No.	4405W (W)	D ₁ (mm)	D ₂ (mm)	ℓ (mm)	L (mm)	 (g)	 (pcs.)
505180	KO4405W06	3/16	16.5	21	9.5	37	46	10
505181	KO4405W08	1/4	19	22	10.5	37	54	10
505182	KO4405W10	5/16	21.5	22	11.5	37	54	10
505183	KO4405W12	3/8	25	24	13	37	73	10
505184	KO4405W14	7/16	29	27	15.5	38	87	10
505185^	KO4405W16	1/2	31.5	29	16.5	40	133	10
505186^	KO4405W18	9/16	35	32	19	42	165	5
505187^	KO4405W20	5/8	37.8	34	20	43	191	5
505188^	KO4405W22	11/16	40	36	22	46	222	5
505189^	KO4405W24	3/4	44.2	39	24	47	280	5

IMPACT

ACCESSORIES

- RS4405W/8**   Socket Set on Rail





Item Code	Part No.	Socket Sets	 (g)
807038^	KORS4405W/8	RS4405W: 8 Piece Set / Rail 250mm 3/16, 1/4, 5/16, 3/8, 7/16, 1/2, 9/16, 5/8	860

AUTOMOTIVE

RENEWAL KITS

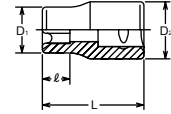
- 4425**  TORX® Sockets



Item Code	Part No.	4425 (E)	D ₁ (mm)	D ₂ (mm)	ℓ (mm)	L (mm)	 (g)	 (pcs.)
505191^	KO4425E10	E10	13.2	21	8.2	36	44	10
505192^	KO4425E12	E12	14.6	21	9.3	37	47	10
505193^	KO4425E14	E14	16.5	21	10.6	37	48	10
505194^	KO4425E16	E16	19	22	11.8	37	57	10
505195^	KO4425E18	E18	20.3	22	13	37	57	10
505196	KO4425E20	E20	22.8	22	14.4	37	63	10
805489^	KO4425E22	E22	25	24	15.5	37	78	10
505198^	KO4425E24	E24	26.5	25	17	40	95	5

- RS4425/7**   TORX® Socket Set on Rail



Item Code	Part No.	Torx® Socket Set	 (g)
505613	KORS4425/7	RS4425: 7 Piece Set/Rail 200mm E10, E12, E14, E16, E18, E20, E24	428

1/2" Sockets & Accessories

Z-SERIES

RS4300M/10   Socket Set on Rail

RS4305M/10  

RS4300A/10   Socket Set on Rail

RS4305A/10  



Item Code	Part No.	Deep Socket Sets	(g)
505604	KORS4300M/10	RS4300M: 10 Pieces Set/Rail 300mm 10, 11, 12, 13, 14, 15, 17, 19, 21, 22	1,415
505606	KORS4305M/10	RS4305M: 10 Pieces Set/Rail 300mm 10, 11, 12, 13, 14, 15, 17, 19, 21, 22	1,415
505603	KORS4300A/10	RS4300A: 10 Pieces Set/Rail 300mm 3/8, 7/16, 1/2, 9/16, 5/8, 11/16, 3/4, 13/16, 7/8, 15/16"	1,600
505605	KORS4305A/10	RS4305A: 10 Pieces Set/Rail 300mm 3/8, 7/16, 1/2, 9/16, 5/8, 11/16, 3/4, 13/16, 7/8, 15/16"	1,600

HAND SOCKETS

SCREWDRIVERS

IMPACT

4300M (L120)  6-point Extra Deep Sockets

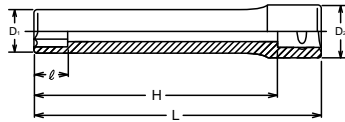

Item Code	Part No.	4300M (L120)(mm)	D ₁ (mm)	D ₂ (mm)	l (mm)	H (mm)	L (mm)	(g)	(pcs.)
806955 [^]	KO4300ML120M08	8	13.2	21	9	102	120	120	5
806952 [^]	KO4300ML120M10	10	15.3	21	11	102	120	138	5
806953 [^]	KO4300ML120M12	12	17.8	21	13	102	120	157	5
806954 [^]	KO4300ML120M14	14	20.3	21.8	15	102	120	193	5
511136 [^]	KO4300ML120M16	16	22.8	22	17	102	120	210	5

ACCESSORIES

AUTOMOTIVE

4325  TORX® Deep Sockets

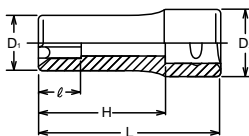

Item Code	Part No.	4325 (E)	D ₁ (mm)	D ₂ (mm)	l (mm)	H (mm)	L (mm)	(g)	(pcs.)
505063 [^]	KO4325E10	E10	13.2	21	8.2	59	77	99	10
505064 [^]	KO4325E12	E12	14.6	21	9.3	59	77	99	10
505065 [^]	KO4325E14	E14	16.5	21	10.6	59	77	103	10
505066 [^]	KO4325E16	E16	19	21.8	11.8	59	77	107	10
505067 [^]	KO4325E18	E18	20.3	21.8	13	59	77	118	10
505068 [^]	KO4325E20	E20	22.8	22	14.4	59	77	141	10

RENEWAL KITS

RS4325/7   Socket Set on Rail



Item Code	Part No.	TORX® Deep Socket Sets	(g)
807037 [^]	KORS4325/7	RS4325: 7 Pieces Set/Rail 200mm E10, E12, E14, E16, E18, E20, E24	900

4020-60  XZN Bit Sockets

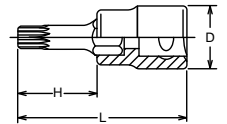

Item Code	Part No.	4020.60 (XZN)	D (mm)	H (mm)	L (mm)	(g)	(pcs.)
504843 [^]	KO4020-60M05	M 5	22	23.5	60	60	10
504844 [^]	KO4020-60M06	M 6	22	23.5	60	61	10
504845 [^]	KO4020-60M08	M 8	22	23.5	60	63	10
504846	KO4020-60M10	M10	23	23.5	60	93	10
504847	KO4020-60M12	M12	23	23.5	60	97	10
504848	KO4020-60M14	M14	24	23.5	60	105	10
504849	KO4020-60M16	M16	25	20	60	165	10
504850	KO4020-60M18	M18	27	20	60	215	5

RS4020/6-L60   XZN Socket Set on Rail



Item Code	Part No.	Socket Set	(g)
505597	KORS4020/6-L60	4020XZN: 6 Piece Set / Rail 150mm M5, M6, M8, M10, M12, M14	500

XZN

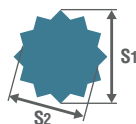

XZN	M4	M5	M6	M8	M10	M12	M14	M16	M18
S1 (ref. mm)	3.6	4.8	6.1	7.3	9.7	11.5	13.3	15.7	16.9
S2 (ref. mm)	3.1	4.1	5.1	6.1	8.1	9.7	11.2	13.2	14.2

1/2" Sockets & Accessories

4025 (T) TORX® Bit Sockets

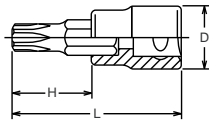

Item Code	Part No.	4025.60 (T)	D (mm)	H (mm)	L (mm)	(g)	(pcs.)
504851	KO4025-60T20	T20	22	23.5	60	59	10
504852	KO4025-60T25	T25	22	23.5	60	60	10
504853	KO4025-60T27	T27	22	23.5	60	60	10
504854	KO4025-60T30	T30	22	23.5	60	60	10
504855	KO4025-60T40	T40	22	23.5	60	62	10
504856	KO4025-60T45	T45	22	23.5	60	64	10
504857	KO4025-60T50	T50	22	23.5	60	74	10
504858	KO4025-60T55	T55	23	23.5	60	96	10
504859	KO4025-60T60	T60	24	23.5	60	122	10

RS4012M/10-L60 Socket Set on Rail

RS4012A/10-L60



Item Code	Part No.	Inhex Socket Sets	(g)
505596	KORS4012M60/10	4012M.60: 10 Piece Set/Rail 300mm 4, 5, 6, 7, 8, 10, 12, 14, 17, 19	910
505595	KORS4012A60/10	4012A.60: 10 Piece Set/Rail 300mm 3/16, 7/32, 1/4, 5/16, 3/8, 7/16, 1/2, 9/16, 5/8, 3/4"	950

⚠ 4012M/A are for hand use only.
Do not use with an impact wrench.

RS4025/9-L60 TORX® Socket Set on Rail



Item Code	Part No.	Inhex Socket Sets	(g)
505598	KORS4025/9	4025.60 (T): 9 Piece Set/Rail 250mm T20, T25, T27, T30, T40, T45, T50, T55, T60	700

3749S-1/2 Reversible Ratchet Short



* Renewal Kits → 3749SRK-1/2

Item Code	Part No.	D (mm)	T (mm)	H (mm)	L (mm)	(g)	(pcs.)
504752	KO3749S-1/2	34	29	14.4	110	200	5

4012M 4012A Inhex sockets, non-impact

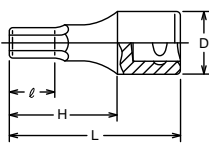

Item Code	Part No.	4012M.60 (mm)	D (mm)	ℓ (mm)	H (mm)	L (mm)	(g)	(pcs.)
504824	KO4012M6004	4	21.1	15.5	38	60	49	10
504825	KO4012M6005	5	21.1	15.5	38	60	55	10
504826	KO4012M6006	6	21.1	15.5	38	60	56	10
504827	KO4012M6007	7	21.1	15.5	38	60	60	10
504828	KO4012M6008	8	21.1	15.5	38	60	64	10
504829	KO4012M6009	9	21.1	15.5	38	60	78	10
504830	KO4012M6010	10	23	15.5	38	60	78	10
504831	KO4012M6012	12	25	15.5	38	60	107	10
504832	KO4012M6014	14	25	15.5	38	60	122	10
504833	KO4012M6015	15	26	15.5	38	60	125	10
504834	KO4012M6016	16	26	15.5	38	60	134	10
504835	KO4012M6017	17	26	15.5	38	60	141	10
504836	KO4012M6019	19	26	15.5	38	60	159	10
504837^	KO4012M6021	21	26	15.5	38	60	197	10
504838	KO4012M6022	22	26	22.5	38	60	205	10
504839	KO4012M6024	24	28	22.5	38	60	245	10

Item Code	Part No.	4012A.60 (inch)	D (mm)	ℓ (mm)	H (mm)	L (mm)	(g)	(pcs.)
504814	KO4012A6005	5/32	21.1	15.5	38	60	49	10
504815	KO4012A6006	3/16	21.1	15.5	38	60	55	10
807085	KO4012A6007	7/32	21.1	15.5	38	60	56	10
504816	KO4012A6008	1/4	21.1	15.5	38	60	57	10
504817	KO4012A6010	5/16	21.1	15.5	38	60	64	10
504818	KO4012A6012	3/8	23	15.5	38	60	74	10
504819	KO4012A6014	7/16	25	15.5	38	60	100	10
504820	KO4012A6016	1/2	25	15.5	38	60	111	10
504821	KO4012A6018	9/16	25	15.5	38	60	122	10
504822	KO4012A6020	5/8	26	15.5	38	60	134	10
504823	KO4012A6024	3/4	26	15.5	38	60	139	10

⚠ 4012M/A are for hand use only.
Do not use with an impact wrench.

4749N-250 Reversible Ratchet

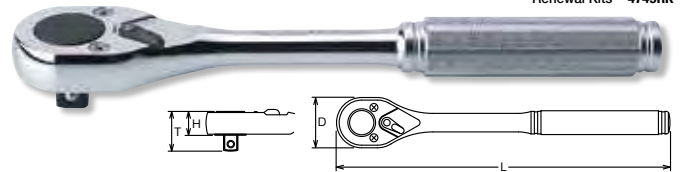

* Renewal Kits → 4749RK

Item Code	Part No.	D (mm)	T (mm)	H (mm)	L (mm)	(g)	(pcs.)
505214	KO4749-250	44.6	33	18.4	250	616	1

4749N-380 Reversible Ratchet Long



* Renewal Kits → 4749RK

4749J-380 Reversible Ratchet Long

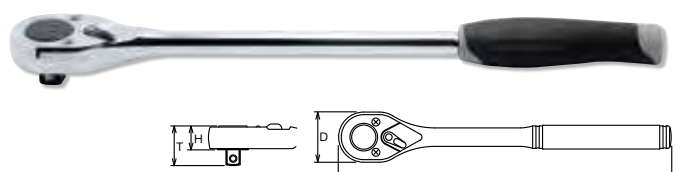

* Renewal Kits → 4749RK

Item Code	Part No.	D (mm)	T (mm)	H (mm)	L (mm)	(g)	(pce.)
505215	KO4749N-380	44.6	33	18.4	380	753	1
806974	KO4749J-380	44.6	33	18.4	380	743	1

Disclaimer: Every effort has been made to publish the correct details in this brochure.
No responsibility will be taken for errors, omissions or changes in product specifications. ^ Special Order Only

1/2" Sockets & Accessories

Z-SERIES



[4750 series]

Two dogs are set in the same axis and the three teeth hold the ratchet gear. The enlarged contact area produces an about 10% higher torque value and the S.O.D.H. system provides smooth and light movements.

HAND SOCKETS

4750N

Reversible Ratchets



* Renewal Kits → 4750RK



4750NB

Reversible Ratchet with quick release button



* Renewal Kits → 4750BRK



SCREWDRIVERS

4750P

Reversible Ratchets



* Renewal Kits → 4750RK



4750PB

Reversible Ratchet with quick release button



* Renewal Kits → 4750BRK



IMPACT

4750J

Reversible Ratchets



* Renewal Kits → 4750RK



4750JB

Reversible Ratchet with quick release button



* Renewal Kits → 4750BRK

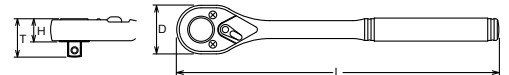
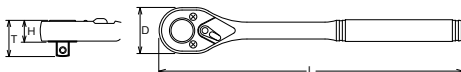

ACCESSORIES

Item Code	Part No.	D (mm)	T (mm)	H (mm)	L (mm)	(g)	(pcs.)
505919^	KO4750N	38	35.9	21.3	250	548	1
505220^	KO4750P	38	35.9	21.3	250	553	1
806975	KO4750J	38	35.9	21.3	250	508	1

Item Code	Part No.	D (mm)	T (mm)	H (mm)	L (mm)	(g)	(pce.)
803476^	KO4750NB	38	35.9	21.3	250	548	1
505221^	KO4750PB	38	35.9	21.3	250	553	1
505219^	KO4750JB	38	35.9	21.3	250	508	1

⚠ Reversible Ratchet with quick release button has less strength compared with normal ratchet due to the technical design. Make sure to use the ratchet correctly.

AUTOMOTIVE

RENEWAL KITS

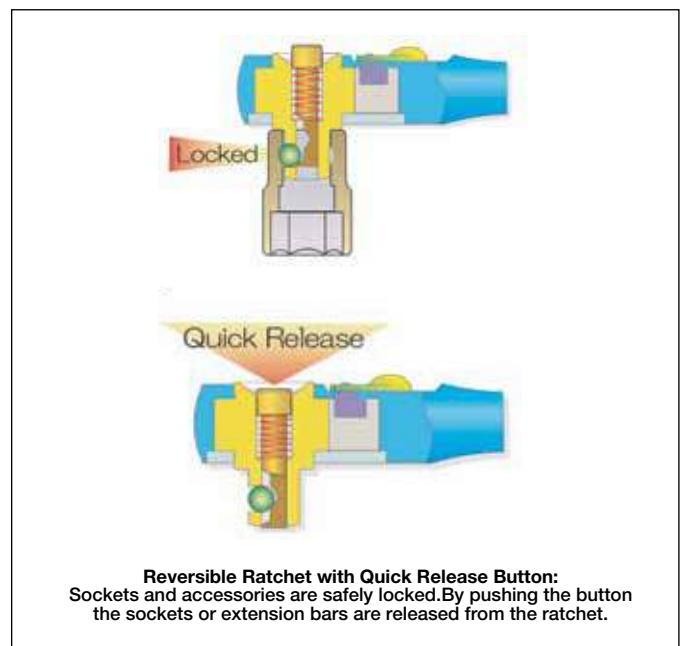

Reversible Ratchet with Quick Release Button:
Sockets and accessories are safely locked. By pushing the button the sockets or extension bars are released from the ratchet.

1/2" Sockets & Accessories

4753N Reversible Ratchets



* Renewal Kits → 4753RK



4753NB Reversible Ratchet with quick release button



* Renewal Kits → 4753BRK



4753P Reversible Ratchets



* Renewal Kits → 4753RK



4753PB Reversible Ratchet with quick release button



* Renewal Kits → 4753BRK



4753J Reversible Ratchets



* Renewal Kits → 4753RK

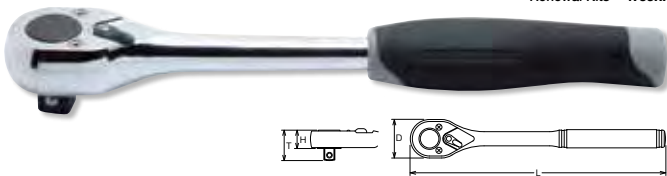

4753JB Reversible Ratchet with quick release button



* Renewal Kits → 4753BRK

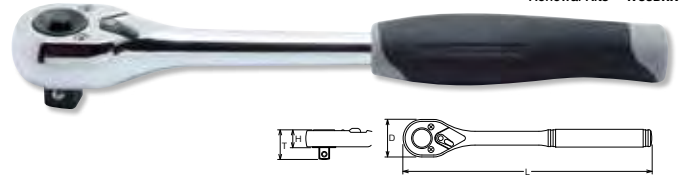

Item Code	Part No.	D (mm)	T (mm)	H (mm)	L (mm)	(g)	(pce.)
505226	KO4753N	38	36.2	21.6	250	595	1
505228	KO4753P	38	36.2	21.6	250	570	1
505921^	KO4753J	38	36.2	21.6	250	510	1

Item Code	Part No.	D (mm)	T (mm)	H (mm)	L (mm)	(g)	(pce.)
505227^	KO4753NB	38	36.2	21.6	250	595	1
505924^	KO4753PB	38	36.2	21.6	250	570	1
807086^	KO4753JB	38	36.2	21.6	250	545	1

⚠ Reversible Ratchet with quick release button has less strength compared with normal ratchet due to the technical design. Make sure to use the ratchet correctly.

4753P-410 Reversible Ratchet Long



* Renewal Kits → 4753RK



Item Code	Part No.	D (mm)	T (mm)	H (mm)	L (mm)	(g)	(pce.)
505229	KO4753P-410	38	36.2	21.6	410	790	1

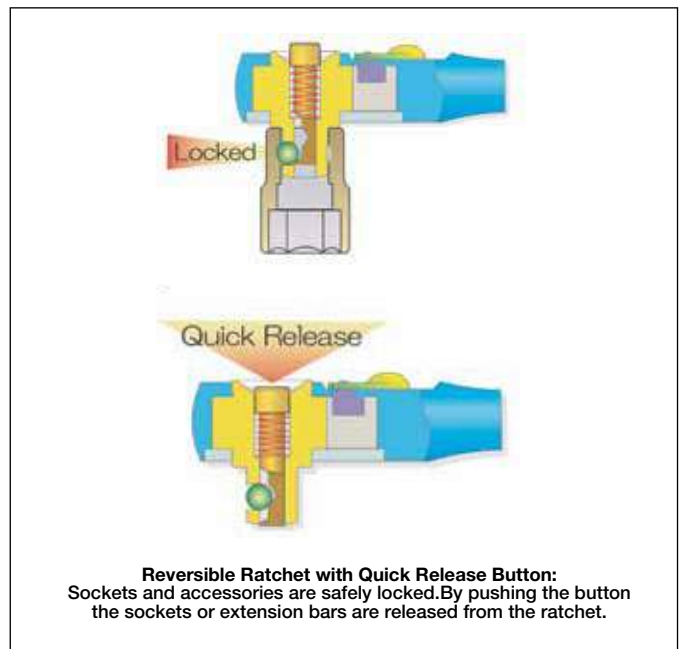

1/2" Sockets & Accessories

Z-SERIES

4774N Flexible Ratchet, Reversible



* Renewal Kits - 4753RK



4774NB Flexible Ratchet, Reversible with Quick Release Button



* Renewal Kits - 4753BRK



HAND SOCKETS

4774P Flexible Ratchet, Reversible



* Renewal Kits - 4753RK

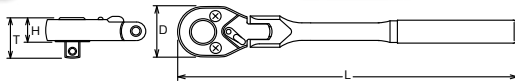

Item Code	Part No.	D (mm)	T (mm)	H (mm)	L (mm)	(g)	(pce.)
505258	KO4774N	38	36.2	21.6	330	700	1
505259	KO4774P	38	36.2	21.6	330	700	1

4774PB Flexible Ratchet, Reversible with Quick Release Button



* Renewal Kits - 4753BRK



SCREWDRIVERS

4774JB Flexible Ratchet, Reversible with Quick Release Button



* Renewal Kits - 4753BRK

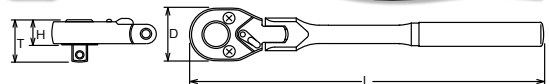

4774P-450 Flexible Ratchet, Reversible



* Renewal Kits - 4753RK

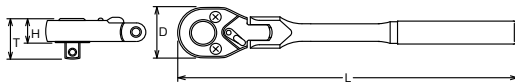

Item Code	Part No.	D (mm)	T (mm)	H (mm)	L (mm)	(g)	(pce.)
505260	KO4774P-450	38	36.2	21.6	450	790	1

⚠ 4774P-450 has longer handle than standard, and can be loaded to excessive torque value. In the interest of your own safety always apply load evenly and progressively to avoid breakage and possible injury.

IMPACT

ACCESSORIES

AUTOMOTIVE

RENEWAL KITS

⚠ Reversible Ratchet with quick release button has less strength compared with normal ratchet due to the technical design. Make sure to use the ratchet correctly.

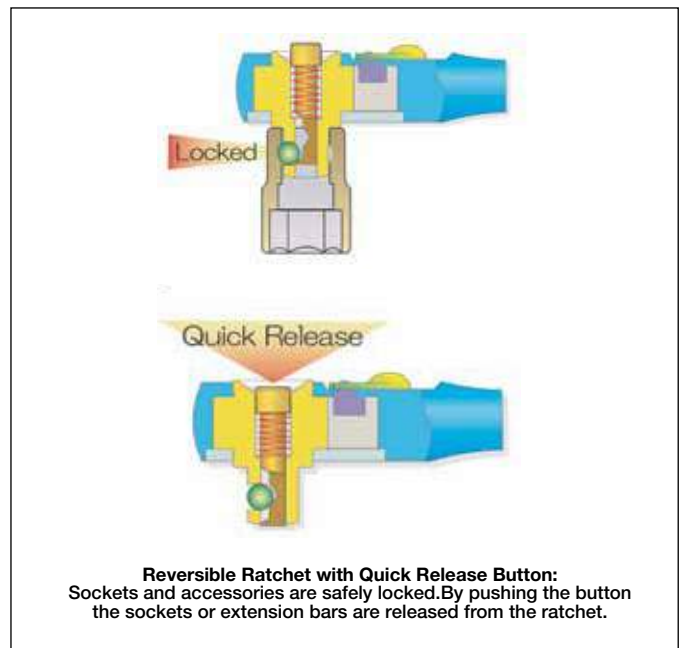

Reversible Ratchet with Quick Release Button:
Sockets and accessories are safely locked. By pushing the button the sockets or extension bars are released from the ratchet.

1/2" Sockets & Accessories

4768N-300 Hinge Handle

* Renewal Kits → 4768RK



4768N- 380 • -450 Hinge Handle



* Renewal Kits → 4768RK



4768P- 380 • -450 Hinge Handle

* Renewal Kits → 4768RK



4768J- 380 • -450 Hinge Handle



* Renewal Kits → 4768RK

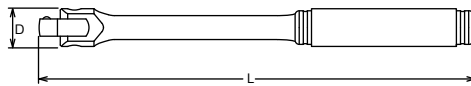

Item Code	Part No.	D (mm)	L (mm)	(g)	(pcs.)
505246	KO4768N300	28	300	600	2
505247	KO4768N380	28	380	696	2
505248	KO4768N450	28	450	784	2
505252^	KO4768P380	28	380	665	2
505929^	KO4768P450	28	450	748	2
505925^	KO4768J380	28	380	600	1
505249^	KO4768J450	28	450	690	1

KO4768P450 and KO4768J450 has longer handle than standard, and can be loaded to excessive torque value. Please use carefully.

4768N-600 Hinge Handle



* Renewal Kits → 4768RK



4768P-600 Hinge Handle



* Renewal Kits → 4768RK



4768J-600 Hinge Handle



* Renewal Kits → 4768RK



Item Code	Part No.	D (mm)	L (mm)	(g)	(pce.)
505251	KO4768N600	28	600	1100	1
505253	KO4768P600	28	600	1170	1
505250	KO4768J600	28	600	1120	1

4768-600 has longer handle than standard, and can be loaded to excessive torque value. In the interest of your own safety always apply load evenly and progressively to avoid breakage and possible injury.

4755 Ratchet Adaptor

45

* Renewal Kits → 4755RK

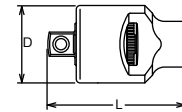

Item Code	Part No.	D (mm)	L (mm)	(g)	(pcs.)
505232	KO4755	33.5	65	270	5

4756 Quick Spinner

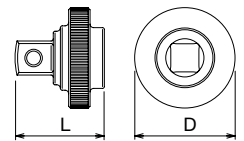

Item Code	Part No.	D (mm)	L (mm)	(g)	(pcs.)
806976^	KO4756	38	34.5	95	10

4770 Universal Joint

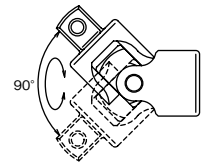
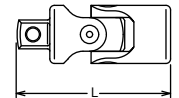

Item Code	Part No.	L (mm)	(g)	(pcs.)
505255	KO4770	62.4	150	10

4771 Universal Joint

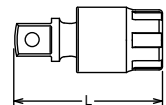

Item Code	Part No.	L (mm)	(g)	(pcs.)
505257	KO4771	57.7	113	10

1/2" Sockets & Accessories

Z-SERIES

4760 Extension Bars



Item Code	Part No.	D (mm)	L (mm)	(g)	(pcs.)
505234	KO4760050	24	50	92	10
505235	KO4760075	24	75	138	10
806977	KO4760100	24	100	158	5
505237	KO4760125	24	125	194	5
806978	KO4760150	24	150	266	5
806979	KO4760200	24	200	295	5
505238	KO4760250	24	250	358	5
806980	KO4760300	24	300	492	2
505239	KO4760400	24	400	650	1
505240	KO4760500	24	500	808	1
505241	KO4760600	24	600	968	1
806981	KO4760900	24	900	1430	1
505236	KO47601000	24	1000	1593	1

HAND SOCKETS

SCREWDRIVERS

PK4760/5 Extension Bar Set



PLASTIC TRAY

Item Code	Part No.	5 Piece Extension Bar Set	(g)
505538	KOPK4760/5	4760 Extension Bars 50, 75, 125, 150, 250mm	1050

IMPACT

ACCESSORIES

4763 Wobble-Fix Extension Bars



Item Code	Part No.	D (mm)	L (mm)	(g)	(pcs.)
505242	KO4763050	24	50	95	10
505243	KO4763075	24	75	111	10
505244	KO4763125	24	125	157	5
511188	KO4763150	24	150	181	5
505245	KO4763250	24	250	357	5
806984	KO4763400	24	400	650	1

⚠ The Wobble-Fix Extension Bar has less strength than normal extension bar due to its specific design with a reduced square drive. Make sure to use it correctly.

AUTOMOTIVE

RENEWAL KITS

Wobble-Fix Extension Bar
Two way usage : one for use as a flexible extension bar to provide a 15° angle operation, the other for use as a normal extension bar. This 2-way usage is Patented.

PK4763/5 Wobble-Fix Extension Bar Set



PLASTIC TRAY

Item Code	Part No.	5 Piece Wobble Fix Extension Bar Set	(g)
505539	KOPK4763/5	4763 Wobble-Fix Extension Bars 50, 75, 125, 150, 250	950

4780 Speed Handle

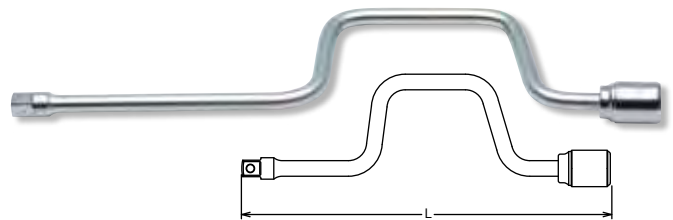

Item Code	Part No.	L (mm)	(g)	(pce.)
505262^	KO4780400	400	644	1
505263^	KO4780450	450	730	1

4785 T-Handle

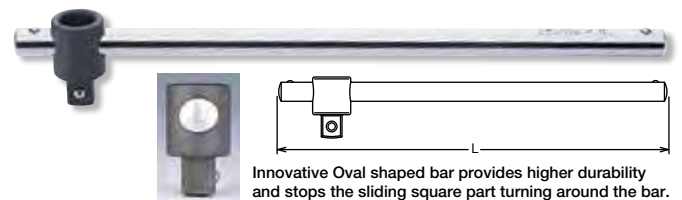

Item Code	Part No.	L (mm)	(g)	(pcs.)
505265	KO4785	300	410	2

4433A35 Reducer Adaptor Warranty 290Nm

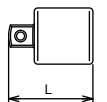

Item Code	Part No.	(sq.)	(sq.)	L (mm)	(g)	(pcs.)
505199	KO4433A35	1/2"	3/8"	35	50	10

⚠ Adapting down from bigger square drive to smaller square drive may lead to excessive torque and possibly cause breakage.

4466A Adaptor

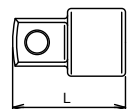

Item Code	Part No.	(sq.)	(sq.)	L (mm)	(g)	(pcs.)
505210	KO4466A	1/2"	3/4"	42	108	10

1/2" Sockets & Accessories

4222M Socket Set



13 Piece Set
METAL CASE:W415xH120xT50mm $\Delta = 2,780g$

Item Code	Part No.	Sockets	Accessories
504927^	KO4222M	4405M 12-pt. Sockets 10, 11, 12, 13, 14, 17, 19, 21, 22, 24	4753N 4760-125 4770

4230M • 4230A Socket Sets



17 Piece Set
METAL CASE:W395xH90xT50mm $\Delta = 3,150g$

Item Code	Part No.	Sockets	Accessories
504931^	KO4230M	4405M 12-pt. Sockets 9, 10, 12, 13, 14, 15, 16, 17, 18, 19, 21, 23, 26	4753N 4760-125 4768N-380 4710

17 Piece Set
METAL CASE:W395xH90xT50mm $\Delta = 3,150g$

Item Code	Part No.	Sockets	Accessories
504930^	KO4230A	4405A 12-pt. Sockets 3/8, 7/16, 1/2, 9/16, 19/32, 5/8, 11/16, 3/4, 25/32, 13/16, 7/8, 15/16, 1"	4753N 4760-125 4768N-380 4710

4239AM Socket Set



40 Piece Set
METAL CASE:W446xH266xT50mm $\Delta = 6,940g$

Item Code	Part No.	Sockets	Accessories
504933	KO4239AM	4405M 12-pt. Sockets 10, 11, 12, 13, 14, 15, 16, 17, 18, 19, 21, 22, 23, 24, 26, 27, 30, 32	4753N 4760-75 4760-125 4760-250 4770 4785
		4405A 12-pt. Sockets 3/8, 7/16, 1/2, 9/16, 5/8, 11/16, 3/4, 13/16, 7/8, 15/16, 1, 1.1/16, 1.1/8, 1.3/16, 1.1/4"	
		4300C S/Plug Sockets 20.8	

4241M Socket Set



28 Piece Set
METAL CASE:W445xH190xT50mm $\Delta = 6,500g$

Item Code	Part No.	Sockets	Accessories
504939	KO4241M	4405M 12-pt. Sockets 10, 11, 12, 13, 14, 15, 16, 17, 18, 19, 20, 21, 22, 23, 24, 25, 26, 27, 28, 29, 30, 32	4753N 4760-125 4760-250 4768N-380 4770 4785



1/2" Sockets & Accessories

Z-SERIES

HAND SOCKETS

SCREWDRIVERS

IMPACT

ACCESSORIES





AUTOMOTIVE

RENEWAL KITS

4241A Socket Set

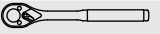
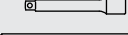
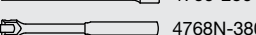
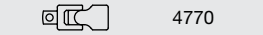



19 Piece Set
METAL CASE: W445xH190xT50mm $\text{⚖} = 5,350\text{g}$

Item Code	Part No.	Sockets	Accessories
504938^	KO4241A	 4405A 12-pt. Sockets 3/8, 7/16, 1/2, 9/16, 5/8, 11/16, 3/4, 13/16, 7/8, 15/16, 1.1/16, 1.1/8, 1.1/4	 4753N
			 4760-125
			 4760-250
			 4768N-380
			 4770
			 4785
			 4785

4250M Socket Set



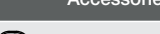
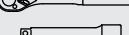
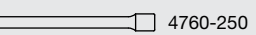
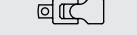
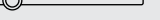

18 Piece Set
METAL CASE: W445xH190xT50mm $\text{⚖} = 3,700\text{g}$

Item Code	Part No.	Sockets	Accessories
504944^	KO4250M	 4405M 12-pt. Sockets 10, 11, 12, 13, 14, 15, 17, 19, 22, 24, 27, 30, 32	 4753N
			 4760-125
			 4760-250
			 4770
			 4785
			 4785
			 4785

4244M · 4244A Socket Sets



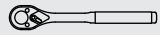
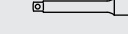
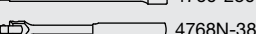
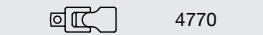
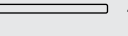
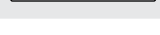

22 Piece Set
METAL CASE: W445xH190xT50mm $\text{⚖} = 5,500\text{g}$

Item Code	Part No.	Sockets	Accessories
504941^	KO4244M	 4405M 12-pt. Sockets 9, 10, 12, 13, 14, 15, 16, 17, 18, 19, 21, 23, 26, 29, 32	 4753N
			 4760-125
			 4760-250
			 4768N-380
			 4770
			 4785
			 4710



4251M · 4251A Socket Sets
4251M-6P



METAL CASE: W330xH68xT48mm

Item Code	Part No.	Sockets	⚖ (g)
504947	KO4251M	 22 Piece Socket Set 4405M 12-pt. Sockets 10, 11, 12, 13, 14, 15, 16, 17, 18, 19, 20, 21, 22, 23, 24, 25, 26, 27, 28, 29, 30, 32	3,200
504948	KO4251M-6P	 22 Piece Socket Set 4405M 6-pt. Sockets 10, 11, 12, 13, 14, 15, 16, 17, 18, 19, 20, 21, 22, 23, 24, 25, 26, 27, 28, 29, 30, 32	3,200
504945	KO4251A	 18 Piece Socket Set 4405A 12-pt. Sockets 3/8, 7/16, 1/2, 9/16, 5/8, 19/32, 21/32, 11/16, 3/4, 25/32, 13/16, 7/8, 15/16, 1, 1.1/16, 1.1/8, 1.3/16, 1.1/4"	2,660

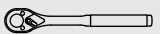
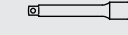
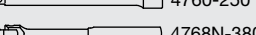
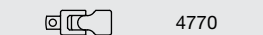
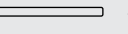
22 Piece Set
METAL CASE: W445xH190xT50mm $\text{⚖} = 5,650\text{g}$

Item Code	Part No.	Sockets	Accessories
504940^	KO4244A	 4405A 12-pt. Sockets 3/8, 7/16, 1/2, 9/16, 19/32, 5/8, 11/16, 3/4, 25/32, 13/16, 7/8, 15/16, 1, 1.1/8, 1.1/4	 4753N
			 4760-125
			 4760-250
			 4768N-380
			 4770
			 4785
			 4710

1/2" Sockets & Accessories

4252M · 4252A Socket Sets



METAL CASE: W168xH60xT42mm

Item Code	Part No.	Socket Sets	(g)
504950 [^]	KO4252M	13 Piece Socket Set 4405M 12-pt. Sockets 10, 11, 12, 13, 14, 15, 16, 17, 18, 19, 20, 21, 22	1,200
504949 [^]	KO4252A	13 Piece Socket Set 4405A 12-pt. Sockets 3/8, 7/16, 1/2, 9/16, 19/32, 5/8, 21/32, 11/16, 3/4, 25/32, 13/16, 7/8, 15/16"	1,300

4267W Whitworth Socket Set



14 Piece Set
METAL CASE: W395xH90xT50mm Δ = 3,150g

Item Code	Part No.	Sockets	Accessories
504953	KO4267W	4405W 12-pt. W/orth Sockets 1/8, 3/16, 1/4, 5/16, 3/8, 7/16, 1/2, 9/16, 5/8, 11/16"	4753N 4760-125 4768N-380 4710

4273AM Socket Set



30 Piece Set
METAL CASE: W446xH266xT50mm Δ = 6,940g

Item Code	Part No.	Sockets	Accessories
504955 [^]	KO4273AM	4405M 12-pt. Sockets 10, 11, 12, 13, 14, 17, 19, 21, 22, 23, 24, 26, 27	4753N 4760-125 4760-250 4768N-380
		4405A 12-pt. Sockets 3/8, 7/16, 1/2, 9/16, 5/8, 11/16, 3/4, 13/16, 7/8, 15/16, 1"	4770 4785

4277 Socket Set



27 Piece Set
METAL CASE: W445xH190xT50mm Δ = 5,660g

Item Code	Part No.	Sockets	Accessories
504957 [^]	KO4277	4405M 12-pt. Sockets 10, 12, 13, 14, 15, 16, 17, 18, 19, 21, 22, 24	4750N 4760-125 4768N-380
		4305M 12-pt. Deep Sockets 10, 12, 13, 14, 15, 16, 17, 18, 19, 21, 22, 24	

4279AM Socket Set



36 Piece Set
METAL CASE: W445xH190xT50mm Δ = 6,000g

Item Code	Part No.	Sockets	Accessories
504958	KO4279AM	4405M 12-pt. Sockets 10, 11, 12, 13, 14, 15, 16, 17, 18, 19, 21, 22, 23, 24, 26, 27, 30, 32	4753N 4760-125 4760-250
		4405A 12-pt. Sockets 3/8, 7/16, 1/2, 9/16, 5/8, 11/16, 3/4, 13/16, 7/8, 15/16, 1.1/16, 1.1/8, 1.1/4"	4770 4785

3/4" Sockets & Accessories

6405M · 6405A 12-point Sockets

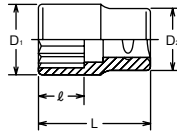

Item Code	Part No.	6405M (mm)	D ₁ (mm)	D ₂ (mm)	ℓ (mm)	L (mm)	(g)	(pcs.)
505383	KO6405M17	17	26	34	12.5	50	175	5
505384	KO6405M18	18	27	34	13	50	178	5
505385	KO6405M19	19	28.5	34	13.5	50	179	5
505386	KO6405M20	20	29.5	34	14	50	185	5
505387	KO6405M21	21	31	34	14.5	50	185	5
505388	KO6405M22	22	32	34	15	50	187	5
505389	KO6405M23	23	33.5	34	16	50	187	5
505390	KO6405M24	24	34.5	34	17	50	200	5
505391	KO6405M25	25	36	34	17.5	50	217	5
505392	KO6405M26	26	37	34	18	50	222	5
505393	KO6405M27	27	38.5	37	19	53	254	5
505394	KO6405M28	28	39.5	38	19.5	53	298	5
505395	KO6405M29	29	41	38	20	55	292	5
505396	KO6405M30	30	42	38	21	55	301	5
505397	KO6405M31	31	43.5	38	22	57	294	5
505398	KO6405M32	32	44.5	40	23	57	351	5
505399	KO6405M33	33	46	40	23.5	57	384	5
505400	KO6405M34	34	47	40	24	57	397	5
505401	KO6405M35	35	48.5	42	24.5	59	422	5
505402	KO6405M36	36	49.5	42	25	59	438	5
505403	KO6405M37	37	51	42	25.5	59	484	5
505404	KO6405M38	38	52	45	26	59	523	5
505405	KO6405M39	39	53.5	45	26.5	59	538	5
505406	KO6405M40	40	54.5	45	27	62	550	5
505407	KO6405M41	41	56	47	28	62	633	5
505408	KO6405M42	42	57	47	28.5	62	652	2
505409	KO6405M43	43	58.5	47	29	62	659	2
505410	KO6405M44	44	59.5	47	29.5	62	657	2
505411	KO6405M45	45	61	47	30	68	734	2
505412	KO6405M46	46	62	47	31	68	791	2
505413	KO6405M47	47	63.5	48	31.5	68	816	2
505414	KO6405M48	48	64.5	45	32	68	800	2
505415	KO6405M50	50	67	48	34	68	880	2
505416	KO6405M52	52	69.5	53	33	72	925	2
505417	KO6405M54	54	72	55	33	72	1040	2
505418	KO6405M55	55	73.5	53	36	72	1006	2
505419	KO6405M56	56	74.5	53	36	72	1092	2
505420	KO6405M57	57	76	53	36	72	1169	2
505421	KO6405M58	58	77	53	36	72	1149	2
505422	KO6405M60	60	79.5	58	39	76	1402	2
505423	KO6405M63	63	83.5	58	39	76	1494	2
505424	KO6405M70	70	92	68	45	84	1785	2

Item Code	Part No.	6405A (inch)	D ₁ (mm)	D ₂ (mm)	ℓ (mm)	L (mm)	(g)	(pcs.)
505352 [^]	KO6405A22	11/16	27	34	13	50	178	5
505353	KO6405A24	3/4	28.5	34	13.5	50	179	5
505354 [^]	KO6405A25	25/32	29.5	34	14	50	185	5
505355	KO6405A26	13/16	31	34	14.5	50	185	5
505356	KO6405A28	7/8	32	34	15	50	187	5
505357	KO6405A30	15/16	34.5	34	17	50	200	5
505358	KO6405A32	1	37	34	18	50	222	5
505359	KO6405A34	1. 1/16	38.5	37	19	53	254	5
505360	KO6405A36	1. 1/8	41	38	20	53	292	5
505361	KO6405A38	1. 3/16	42	38	21	55	301	5
505362	KO6405A40	1. 1/4	44.5	40	23	57	351	5
505363	KO6405A42	1. 5/16	46	40	23.5	57	384	5
505364	KO6405A44	1. 3/8	48.5	42	24.5	57	422	5
505365	KO6405A46	1. 7/16	51	42	25.5	59	484	5
505366	KO6405A48	1. 1/2	52	45	26	59	523	5
505367 [^]	KO6405A50	1. 9/16	54.5	45	27	59	550	5
505368 [^]	KO6405A52	1. 5/8	56	47	28	62	633	5
505369	KO6405A54	1. 11/16	58.5	47	29	62	659	2
505370 [^]	KO6405A56	1. 3/4	59.5	47	29.5	62	657	2
505371	KO6405A58	1. 13/16	62	47	31	68	791	2
505372	KO6405A60	1. 7/8	64.5	45	32	68	892	2
505373 [^]	KO6405A62	1. 15/16	66	48	32.5	68	870	2
505374 [^]	KO6405A64	2	68.5	52	34.5	68	949	2
505375	KO6405A66	2. 1/16	71	54	33	72	983	2
505376	KO6405A68	2. 1/8	72	55	33	72	1040	2
505377	KO6405A70	2. 3/16	74.5	53	36	72	1092	2
505378	KO6405A72	2. 1/4	76	53	36	72	1169	2
505379	KO6405A74	2. 5/16	78.5	53	36	72	1344	2
505380	KO6405A76	2. 3/8	79.5	58	39	76	1402	2
505381 [^]	KO6405A78	2. 7/16	82	58	39	76	1420	2
505382	KO6405A80	2. 1/2	84.5	58	39	76	1497	2

6012M-75 Inhex Sockets

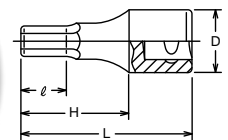

Item Code	Part No.	6012M.75 (mm)	D (mm)	ℓ (mm)	H (mm)	L (mm)	(g)	(pcs.)
806987	KO6012M12	12	35	15.5	40	75	253	10
505266	KO6012M14	14	35	15.5	40	75	265	10
806988	KO6012M15	15	35	15.5	40	75	271	10
806989	KO6012M16	16	35	15.5	40	75	285	10
505267	KO6012M17	17	35	15.5	40	75	292	10
806990	KO6012M18	18	35	15.5	40	75	302	10
505268	KO6012M19	19	35	15.5	40	75	312	10
806991	KO6012M20	20	35	15.5	40	75	323	10
806992	KO6012M21	21	38	15.5	40	75	330	10
505269	KO6012M22	22	38	22.5	40	75	340	10
505270	KO6012M24	24	38	22.5	40	75	362	10
505271	KO6012M27	27	38	22.5	40	75	402	10
806993	KO6012M30	30	38	28.5	40	75	445	10
806994	KO6012M32	32	38	28.5	40	75	485	10
806995	KO6012M36	36	42	28.5	40	75	663	10

3/4" Sockets & Accessories

6305M · 6305A  12-point Deep Sockets

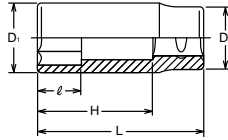

Item Code	Part No.	6305M (mm)	D ₁ (mm)	D ₂ (mm)	ℓ (mm)	H (mm)	L (mm)	(g)	(pcs.)
505317	KO6305M17	17	26	34	18	64	90	278	5
505318	KO6305M19	19	28.5	34	20	64	90	292	5
505319	KO6305M20	20	29.5	34	21	64	90	334	5
505320	KO6305M21	21	31	34	22	64	90	343	5
505321	KO6305M22	22	32	34	23	64	90	347	5
505322	KO6305M23	23	33.5	34	24	64	90	361	5
505323	KO6305M24	24	34.5	34	25	64	90	352	5
505324	KO6305M25	25	36	34	26	64	90	369	5
505325	KO6305M26	26	37	34	27	64	90	384	5
505326	KO6305M27	27	38.5	37	28	64	90	425	5
505327	KO6305M28	28	39.5	38	29	63	90	470	5
505328	KO6305M29	29	41	38	30	63	90	503	5
505329	KO6305M30	30	42	38	31	63	90	503	5
505330	KO6305M31	31	43.5	38	32	62	90	517	5
505331	KO6305M32	32	44.5	40	34	62	90	544	5
505332	KO6305M33	33	46	40	34	62	90	557	5
505333	KO6305M34	34	47	40	35	61	90	570	5
505334	KO6305M35	35	48.5	42	36	61	90	622	5
505335	KO6305M36	36	49.5	42	37	61	90	631	2
505336	KO6305M38	38	52	45	39	60	90	710	2
505337	KO6305M40	40	54.5	45	41	60	90	742	2
505338	KO6305M41	41	56	47	42	59	90	802	2
505339	KO6305M42	42	57	47	43	59	90	829	2
505340	KO6305M43	43	59.5	47	45	59	90	838	2
505341	KO6305M44	44	59.5	47	47	58	90	906	2
505342	KO6305M46	46	62	47	47	57	90	998	2
505343	KO6305M50	50	67	48	51	57	90	1005	2
505344	KO6305M53	53	71	54	49	-	100	1338	2
505345	KO6305M54	54	72	55	49	-	100	1351	2
505346	KO6305M55	55	73.5	53	52	-	100	1388	2
505347	KO6305M57	57	76	53	52	-	100	1467	2
505348	KO6305M58	58	77	53	52	-	100	1480	2
505349	KO6305M60	60	79.5	58	55	-	100	1626	2
505350	KO6305M63	63	83.5	58	55	-	100	1740	2
807003	KO6305M65	65	86	63	65	-	100	1939	2

Item Code	Part No.	6305A (inch)	D ₁ (mm)	D ₂ (mm)	ℓ (mm)	H (mm)	L (mm)	(g)	(pcs.)
505291 [^]	KO6305A24	3/4	28.5	34	20	64	90	292	5
505292 [^]	KO6305A26	13/16	31	34	22	64	90	343	5
505293 [^]	KO6305A28	7/8	32	34	23	64	90	347	5
505294 [^]	KO6305A30	15/16	34.5	34	25	64	90	352	5
505295 [^]	KO6305A32	1	37	34	27	64	90	384	5
505296 [^]	KO6305A34	1. 1/16	38.5	37	28	64	90	425	5
505297	KO6305A36	1. 1/8	41	38	30	63	90	503	5
505298 [^]	KO6305A38	1. 3/16	42	38	31	63	90	503	5
505299	KO6305A40	1. 1/4	44.5	40	34	62	90	544	5
505300	KO6305A42	1. 5/16	46	40	34	62	90	557	5
505301 [^]	KO6305A44	1. 3/8	48.5	42	36	61	90	622	5
505302 [^]	KO6305A46	1. 7/16	51	42	38	61	90	656	2
505303	KO6305A48	1. 1/2	52	45	39	60	90	710	2
505304 [^]	KO6305A50	1. 9/16	54.5	45	41	60	90	742	2
505305 [^]	KO6305A52	1. 5/8	56	47	42	59	90	802	2
505306 [^]	KO6305A54	1. 11/16	58.5	47	44	59	90	831	2
505307 [^]	KO6305A56	1. 3/4	59.5	47	45	59	90	838	2
505937 [^]	KO6305A58	1. 13/16	62	47	47	58	90	906	2
505308 [^]	KO6305A64	2	68.5	52	52	57	90	1061	2
505309 [^]	KO6305A66	2. 1/16	71	54	49	-	100	1338	2
505310 [^]	KO6305A68	2. 1/8	72	55	49	-	100	1351	2
505311 [^]	KO6305A70	2. 3/16	74.5	53	52	-	100	1389	2
505312 [^]	KO6305A72	2. 1/4	76	53	52	-	100	1467	2
505313 [^]	KO6305A74	2. 5/16	78.5	53	52	-	100	1787	2
505314 [^]	KO6305A76	2. 3/8	79.5	58	55	-	100	1626	2
505315 [^]	KO6305A78	2. 7/16	82	58	55	-	100	1715	2
505316 [^]	KO6305A80	2. 1/2	84.5	58	69	-	100	1640	2

6749 Reversible Ratchet



* Renewal Kits → 6749RK



6749-1000 Reversible Ratchet



* Renewal Kits → 6749RK

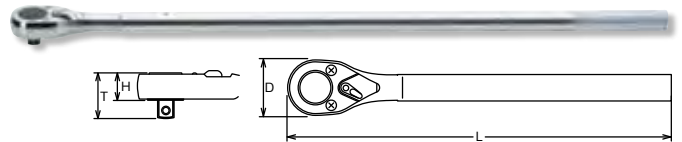

Item Code	Part No.	D (mm)	T (mm)	H (mm)	L (mm)	(g)	(pce.)
505429	KO6749	68	49.6	29.6	565	2800	1
505428	KO67491000	68	49.6	29.6	1000	3600	1

6755 Ratchet Adaptor

60

* Renewal Kits → 6755RK

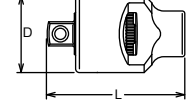

Item Code	Part No.	D (mm)	L (mm)	(g)	(pce.)
505434	KO6755	62	97	1162	1

6760 Extension Bars



Item Code	Part No.	D (mm)	L (mm)	(g)	(pcs.)
505436	KO6760075	35	75	335	10
807005	KO6760100	35	100	434	10
807006	KO6760125	35	125	528	10
807007	KO6760150	35	150	624	2
505437	KO6760200	35	200	815	1
505943	KO6760300	35	300	1203	1
505438	KO6760400	35	400	1585	1

6768 Hinge Handle

* Renewal Kits → 6768RK

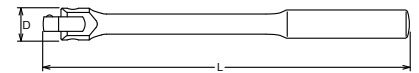

Item Code	Part No.	D (mm)	L (mm)	(g)	(pcs.)
505439	KO6768	42	450	1780	1
505441	KO6768600	42	600	2900	1
505440	KO67681000	42	1000	3500	1

6785 T-Handle

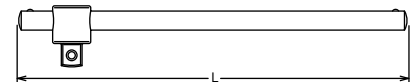
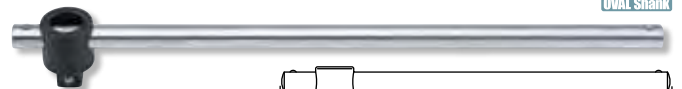

Item Code	Part No.	L (mm)	(g)	(pce.)
505445	KO6785	500	1500	1

3/4" Sockets & Accessories

Z-SERIES

6770 Universal Joint

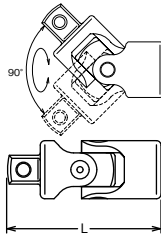

Item Code	Part No.	L (mm)	(g)	(pcs.)
505443	KO6770	105	478	2

HAND SOCKETS

6644A Reducer

Warranty 668Nm ⚠

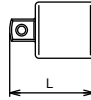

Item Code	Part No.	(sq.)	(sq.)	L (mm)	(g)	(pcs.)
505425	KO6644A	3/4"	1/2"	47	136	5

SCREWDRIVERS

6688A Adaptor

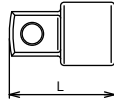

Item Code	Part No.	(sq.)	(sq.)	L (mm)	(g)	(pcs.)
505426	KO6688A	3/4"	1"	60	285	5

IMPACT

6201M 6201A Socket Sets



16 Piece Set
METAL CASE: W580xH200xT85mm ⚖ = 17,300g

Item Code	Part No.	Sockets	Accessories
505278 [^]	KO6201M	6405M 12-pt. Sockets 22, 24, 27, 30, 32, 36, 41, 46, 50, 55, 60	6749 6760-200 6760-400 6768 6785

ACCESSORIES

AUTOMOTIVE

18 Piece Set
METAL CASE: W580xH200xT85mm ⚖ = 17,600g

Item Code	Part No.	Sockets	Accessories
505276 [^]	KO6201A	6405A 12-pt. Sockets 7/8, 15/16, 1.1/16, 1.1/8, 1.1/4, 1.5/16, 1.7/16, 1.1/2, 1.5/8, 1.11/16, 1.13/16, 1.7/8, 2"	6749 6760-200 6760-400 6768 6785

RENEWAL KITS

6212M 6212A Socket Sets



12 Piece Set
METAL CASE: W580xH124xT70mm ⚖ = 11,000g

Item Code	Part No.	Sockets	Accessories
505279 [^]	KO6212M	6405M 12-pt. Sockets 22, 24, 27, 30, 32, 36, 41, 46, 50	6749 6760-200 6785

12 Piece Set
METAL CASE: W580xH124xT70mm ⚖ = 11,000g

Item Code	Part No.	Sockets	Accessories
807002 [^]	KO6212A	6405A 12-pt. Sockets 7/8, 15/16, 1.1/16, 1.3/16, 1.1/4, 1.7/16, 1.5/8, 1.13/16, 2"	6749 6760-200 6785

6260M 6260A Socket Sets



20 Piece Set
METAL CASE: W580xH200xT85mm ⚖ = 15,800g

Item Code	Part No.	Sockets	Accessories
505285 [^]	KO6260M	6405M 12-pt. Sockets 21, 23, 26, 29, 31, 32, 34, 35, 36, 38, 41, 46, 50	6749 6760-75 6760-200 6760-400 6770 6785
		6101 Drag Link Socket	

25 Piece Set
METAL CASE: W580xH200xT85mm ⚖ = 19,000g

Item Code	Part No.	Sockets	Accessories
505284 [^]	KO6260A	6405A 12-pt. Sockets 15/16, 31/32, 1, 1.1/16, 1.1/8, 1.3/16, 1.1/4, 1.5/16, 1.3/8, 1.7/16, 1.1/2, 1.9/16, 1.5/8, 1.11/16, 1.3/4, 1.13/16, 1.7/8, 2"	6749 6760-75 6760-200 6760-400 6770 6785
		6101 Drag Link Socket	

1" Sockets & Accessories

8405M · 8405A 12-point Sockets

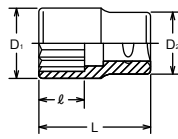

Item Code	Part No.	8405M (mm)	D ₁ (mm)	D ₂ (mm)	ℓ (mm)	L (mm)	(g)	(pce.)
505484 [^]	KO8405M27	27	40.5	44	19	60	362	1
807013	KO8405M28	28	41.5	44	19.5	60	368	1
807014	KO8405M29	29	43	44	20	60	378	1
505485	KO8405M32	32	46.5	45	23	65	455	1
505486 [^]	KO8405M33	33	48	46	23.5	65	485	1
505487 [^]	KO8405M35	35	50.5	48	24.5	65	536	1
505488	KO8405M36	36	51.5	48	25	65	600	1
505489 [^]	KO8405M38	38	54	50	26	65	624	1
807015	KO8405M39	39	55.5	50	26.5	65	650	1
505490	KO8405M40	40	56.5	53	27	65	686	1
505491	KO8405M41	41	58	53	28	68	747	1
807016	KO8405M45	45	63	53	30	68	844	1
505492	KO8405M46	46	64	53	31	72	928	1
807017	KO8405M47	47	65.5	53	31.5	72	942	1
505493	KO8405M50	50	69	53	34	72	943	1
807018	KO8405M52	52	71.5	53	38	72	987	1
505494 [^]	KO8405M54	54	74	55	37	72	1016	1
505495	KO8405M55	55	75.5	53	42	77	1167	1
505496	KO8405M58	58	79	53	41	77	1200	1
505497	KO8405M60	60	81.5	58	46	82	1440	1
505498	KO8405M63	63	85.5	58	45	82	1470	1
505499	KO8405M65	65	88	63	49	86	1683	1
505500	KO8405M67	67	90.5	63	49	86	1840	1
505501	KO8405M70	70	94	68	50	88	1963	1
505502 [^]	KO8405M71	71	95.5	68	50	88	2200	1
505503	KO8405M75	75	100.5	73	53	90	2204	1
807019	KO8405M78	78	104	75	52.5	90	2500	1
505504 [^]	KO8405M80	80	106.5	75	58	95	2550	1
807020	KO8405M85	85	113	80	57	95	2680	1
807012	KO8405M100	100	131.5	85	57	100	4840	1

Item Code	Part No.	8405A (inch)	D ₁ (mm)	D ₂ (mm)	ℓ (mm)	L (mm)	(g)	(pce.)
505455 [^]	KO8405A34	1. 1/16	40.5	44	19	60	365	1
505456 [^]	KO8405A40	1. 1/4	46.5	45	23	65	455	1
505457 [^]	KO8405A42	1. 5/16	48	46	23.5	65	485	1
505458 [^]	KO8405A44	1. 3/8	50.5	48	24.5	65	536	1
505459 [^]	KO8405A46	1. 7/16	53	50	25.5	65	607	1
505460	KO8405A48	1. 1/2	54	50	26	65	624	1
505461 [^]	KO8405A50	1. 9/16	56.5	53	27	65	686	1
505462 [^]	KO8405A52	1. 5/8	58	53	28	68	747	1
505463 [^]	KO8405A54	1.11/16	60.5	53	29	68	830	1
505464 [^]	KO8405A56	1. 3/4	61.5	53	29.5	68	807	1
505465 [^]	KO8405A58	1.13/16	64	53	31	72	928	1
505466 [^]	KO8405A60	1. 7/8	66.5	53	32	72	936	1
505467 [^]	KO8405A64	2	70.5	53	37	72	976	1
505468 [^]	KO8405A66	2. 1/16	73	54	37	72	1027	1
505469 [^]	KO8405A68	2. 1/8	74	55	37	72	1016	1
505470 [^]	KO8405A70	2. 3/16	76.5	53	41	77	1192	1
505471 [^]	KO8405A72	2. 1/4	78	53	41	77	1177	1
505472 [^]	KO8405A74	2. 5/16	80.5	53	41	77	1292	1
505473 [^]	KO8405A76	2. 3/8	81.5	58	46	82	1440	1
505474 [^]	KO8405A78	2. 7/16	84	58	45	82	1495	1
505475 [^]	KO8405A80	2. 1/2	86.5	58	45	82	1497	1
505476 [^]	KO8405A82	2. 9/16	88	63	49	86	1683	1
505477 [^]	KO8405A84	2. 5/8	90.5	63	49	86	1840	1
505478 [^]	KO8405A86	2.11/16	91.5	63	49	86	1800	1
505479 [^]	KO8405A88	2. 3/4	94	68	50	88	1963	1
505480 [^]	KO8405A90	2.13/16	96.5	68	50	88	2035	1
505481 [^]	KO8405A92	2. 7/8	98	70	50	88	2100	1
505482 [^]	KO8405A94	2.15/16	100.5	73	53	90	2204	1
505483 [^]	KO8405A96	3	103	75	53	90	2406	1
505452 [^]	KO8405A100	3. 1/8	106.5	75	58	95	2550	1
505453 [^]	KO8405A104	3. 1/4	110.5	78	57	95	2730	1
505454 [^]	KO8405A112	3. 1/2	119	80	59	100	3420	1

8760 Extension Bars

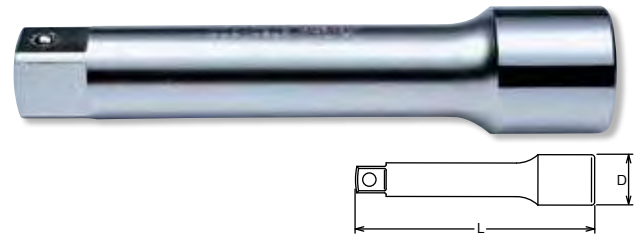

Item Code	Part No.	D (mm)	L (mm)	(g)	(pce.)
505509	KO8760200	44	200	1300	1
505510	KO8760400	44	400	2570	1

8770 Universal Joint



Item Code	Part No.	L (mm)	(g)	(pce.)
505513	KO8770	143	1170	1

8866A Reducer

Warranty 1850Nm 



Item Code	Part No.	(mm)	(mm)	L (mm)	(g)	(pcs.)
505516	KO8866A	1"	3/4"	60	338	5

 Adapting down from bigger square drive to smaller square drive may lead to excessive torque and possibly cause breakage.

8749 Reversible Ratchet

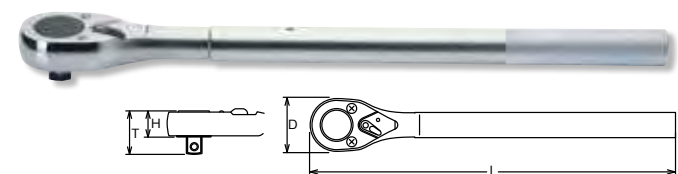

* Renewal Kits → 8749RK

Item Code	Part No.	D (mm)	T (mm)	H (mm)	L (mm)	(g)	(pce.)
505505	KO8749	70	62.2	36.2	800	4090	1

1" Sockets & Accessories

Z-SERIES

8768 Hinge Handle

* Renewal Kits -- 8768RK

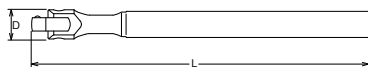

Item Code	Part No.	D (mm)	L (mm)	(g)	(pce.)
505511	KO8768	55	600	3190	1
807021^	KO87681000	55	1000	4348	1

HAND SOCKETS

8785 T-Handle

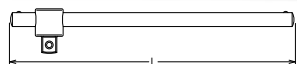

Item Code	Part No.	L (mm)	(g)	(pce.)
505515	KO8785	550	3190	1

SCREWDRIVERS

8788 L-Handle

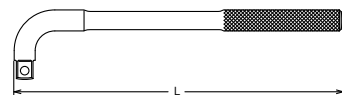

Item Code	Part No.	L (mm)	(g)	(pce.)
505944^	KO8788	600	3600	1

IMPACT

ACCESSORIES

AUTOMOTIVE

RENEWAL KITS

8200M

Socket Sets

8200A



12 Piece Set
METAL CASE:W600xH150xT110mm

⚖️ = 18,600g

Item Code	Part No.	Sockets	Accessories
505448^	KO8200M	8405M 12-pt. Sockets 35, 38, 41, 46, 50, 54, 58, 63	8760-200
			8760-400
			8770
			8785

12 Piece Set
METAL CASE:W600xH150xT110mm

⚖️ = 18,600g

Item Code	Part No.	Sockets	Accessories
505447^	KO8200A	8405A 12-pt. Sockets 1.7/16, 1.1/2, 1.5/8, 1.13/16, 2, 2.1/8, 2.1/4, 2.1/2"	8760-200
			8760-400
			8770
			8785



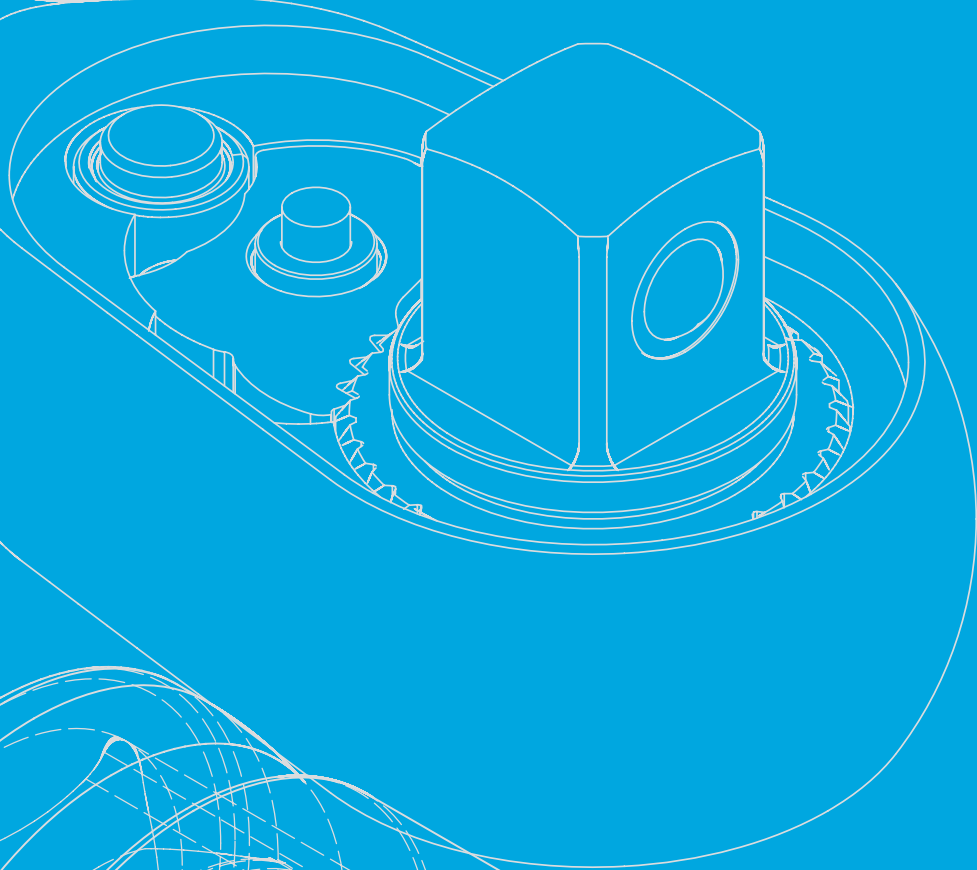

Screwdrivers



Screwdrivers

Z-SERIES

HAND SOCKETS

SCREWDRIVERS

IMPACT

ACCESSORIES

AUTOMOTIVE

RENEWAL KITS

167M

Socket Drivers (Spin-Tites)

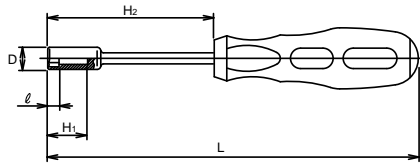

Item Code	Part No.	167M (mm)	D (mm)	l (mm)	H ₁ (mm)	H ₂ (mm)	L (mm)	(g)	(pcs.)
504049	KO167M03	3	5.8	3	25	125	225	62	6
504050	KO167M03.5	3.5	5.8	3	25	125	225	62	6
504051	KO167M04	4	6.7	3.5	25	125	225	64	6
504052	KO167M04.5	4.5	7.2	4.5	25	125	225	65	6
504053	KO167M05	5	7.8	5	25	125	225	66	6
504054	KO167M05.5	5.5	8.4	5.5	25	125	225	68	6
504055	KO167M06	6	9.1	6	25	125	225	70	6
504056	KO167M07	7	10.9	6.5	25	125	235	101	6
504057	KO167M08	8	12	7	25	125	235	103	6
806660	KO167M09	9	13.2	7.5	25	125	235	107	6
504058	KO167M10	10	14.5	8	25	125	235	111	6
806661	KO167M11	11	15.9	8.5	25	125	245	155	6
504059	KO167M12	12	16.8	9	25	125	245	161	6
504060	KO167M13	13	18.2	9.5	25	125	245	167	6
504061	KO167M14	14	19.2	11	25	125	245	178	6

168H-B

Ball point Hex Screwdrivers

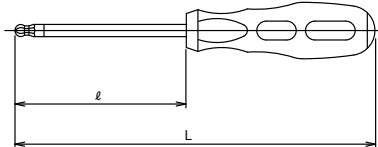

Item Code	Part No.	168H (mm)	l (mm)	L (mm)	(g)	(pcs.)
504063^	KO168HB3	3B	80	150	25	6
504064^	KO168HB4	4B	125	225	60	6
504065^	KO168HB5	5B	125	235	85	6
504066^	KO168HB6	6B	125	245	150	6
504067^	KO168HB7	7B	125	245	151	6
504068^	KO168HB8	8B	125	245	153	6

⚠ Ball point Hex Screwdrivers have less strength due to the special design. Make sure to use them correctly.

168T (TH)

Tamper-Resistant TORX® Screwdrivers

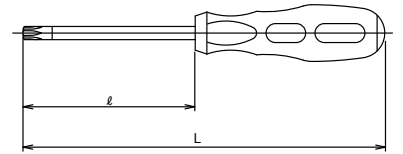

Item Code	Part No.	168T (TH)	l (mm)	L (mm)	(g)	(pcs.)
504077^	KO168T-T10H	T10H	80	150	25	6
504078^	KO168T-T15H	T15H	80	150	25	6
504079^	KO168T-T20H	T20H	125	225	60	6
504080^	KO168T-T25H	T25H	125	225	60	6
504081^	KO168T-T27H	T27H	125	235	90	6
504082^	KO168T-T30H	T30H	125	235	92	6
504083^	KO168T-T40H	T40H	125	245	153	6

168T/7 (TH)

Tamper-Resistant Torx® Screwdriver Set



Item Code	Part No.	168T	(g)
504076^	KO168T/7	7 Piece Set 168T: T10H, T15H, T20H, T25H, T27H, T30H, T40H	480

⚠ Tamper Resistant TORX® Screwdrivers have less strength due to the special design. Make sure to use it correctly.



Screwdrivers

166P Screwdrivers (Blade-Through type)

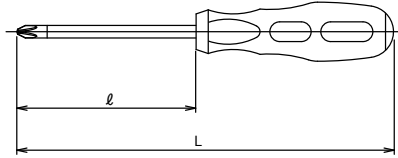

Item Code	Part No.	166P (PH)	ℓ (mm)	L (mm)	(g)	(pcs.)
504036	KO166P1	1	75	175	78	6
504037	KO166P2	2	100	210	129	6
504038	KO166P3	3	150	270	203	6

168P Screwdrivers

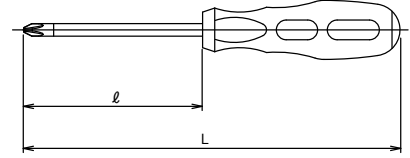

Item Code	Part No.	168P (PH)	ℓ (mm)	L (mm)	(g)	(pcs.)
504069^	KO168P1	1	75	175	59	6
504070^	KO168P2	2	100	210	86	6
504071^	KO168P3	3	150	270	150	6

166S Screwdrivers (Blade-Through type)

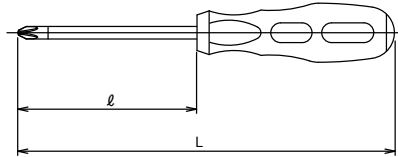

Item Code	Part No.	166S (S)	ℓ (mm)	L (mm)	(g)	(pcs.)
504040	KO166S5	5	75	175	78	6
504041	KO166S6	6	100	210	129	6
504042	KO166S8	8	150	270	203	6

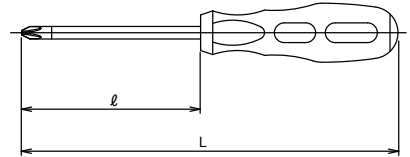

168S Screwdrivers



Item Code	Part No.	168S (S)	ℓ (mm)	L (mm)	(g)	(pcs.)
504073^	KO168S5	5	75	175	59	6
504074^	KO168S6	6	100	210	86	6
504075^	KO168S8	8	150	270	150	6



166PS/6 Screwdriver Set (Blade Through Type)



Item Code	Part No.	6 Piece Screwdriver Set	(g)
504039	KO166PS/6	 166P Screwdrivers 1, 2, 3  166S Screwdrivers 5, 6, 8	885

168PS/6 Screwdriver Set



Item Code	Part No.	6 Piece Screwdriver Set	(g)
504072	KO168PS/6	 168P Screwdrivers 1, 2, 3  168S Screwdrivers 5, 6, 8	660



Impact Sockets

1/4"

3/8"

1/2"

3/4"

1"

1-1/2"



1/4" Impact Sockets & Accessories

Z-SERIES

HAND SOCKETS

SCREWDRIVERS

IMPACT

ACCESSORIES

AUTOMOTIVE

RENEWAL KITS

12400M · 12400A 6-point Sockets

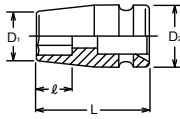



Item Code	Part No.	12400M (mm)	D ₁ (mm)	D ₂ (mm)	ℓ (mm)	L (mm)	(g)	(pcs.)	
806371	KO12400M04	4	7.5	13	4	23	14	10	*1
505630	KO12400M05	5	8.8	13	4	23	14	10	*1
503653	KO12400M06	6	10	13	5	23	14	10	*1
503654	KO12400M07	7	11.3	13	5	23	14	10	*1
503655	KO12400M08	8	12.5	13	6	23	14	10	*1
806372	KO12400M09	9	13.8	13	7	23	14	10	*1
503656	KO12400M10	10	15	13	7	23	15	10	*1
806368	KO12400M11	11	16.3	13	8	23	18	10	*1
503657	KO12400M12	12	17.5	13	8	23	19	10	*1
806369	KO12400M13	13	18.8	13	8	23	19	10	*1
806370	KO12400M14	14	20	13	9	23	20	10	*1

Item Code	Part No.	12400A (inch)	D ₁ (mm)	D ₂ (mm)	ℓ (mm)	L (mm)	(g)	(pcs.)	
503652	KO12400A08	1/4	10	13	5	23	14	10	*1
806367	KO12400A09	9/32	11.3	13	5	23	14	10	*1
806361	KO12400A10	5/16	12.5	13	6	23	14	10	*1
806362	KO12400A11	11/32	13.8	13	7	23	14	10	*1
806363	KO12400A12	3/8	15	13	7	23	15	10	*1
806364	KO12400A14	7/16	16.3	13	8	23	18	10	*1
806365	KO12400A16	1/2	18.8	13	8	23	19	10	*1
806366	KO12400A18	9/16	20	13	9	23	20	10	*1

*1 Pin/O-Ring=1200A/B

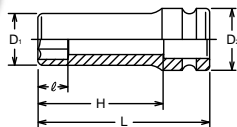
12300M 6-point Sockets, Deep



Item Code	Part No.	12300M (mm)	D ₁ (mm)	D ₂ (mm)	ℓ (mm)	H (mm)	L (mm)	(g)	(pcs.)	
806354	KO12300M06	6	10	13	6	38	48	26	10	*1
806355	KO12300M07	7	11.3	13	7	38	48	30	10	*1
806356	KO12300M08	8	12.5	13	8	38	48	32	10	*1
806350	KO12300M10	10	15	13	10	37	48	34	10	*1
806351	KO12300M12	12	17.5	13	12	37	48	49	10	*1
806352	KO12300M13	13	18.8	13	13	37	48	52	10	*1
806353	KO12300M14	14	20	13	14	36	48	57	10	*1

*1 Pin/O-Ring=1200A/B

12365M Pathfinder Sockets, Deep

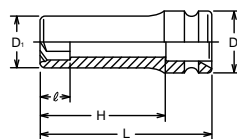

Item Code	Part No.	12365M (mm)	D ₁ (mm)	D ₂ (mm)	ℓ (mm)	H (mm)	L (mm)	(g)	(pcs.)	
806357^	KO12365M10	10	15	13	8	37	48	34	10	*1
806358^	KO12365M11	11	16.3	13	8	37	48	46	10	*1
806359^	KO12365M12	12	17.5	13	9	37	48	49	10	*1
806360^	KO12365M13	13	18.8	13	9	37	48	52	10	*1

*1 Pin/O-Ring=1200A/B

12760-55 · -75 · -100 · -150 Extension Bars

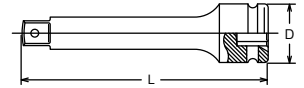

Item Code	Part No.	D (mm)	L (mm)	(g)	(pcs.)	
806375^	KO12760055	13	55	26	10	*1
806376^	KO12760075	13	75	45	10	*1
806373^	KO12760100	13	100	50	10	*1
806374^	KO12760150	13	150	60	10	*1

*1 Pin/O-Ring=1200A/B

12770 Universal Joint

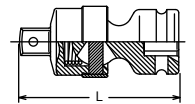
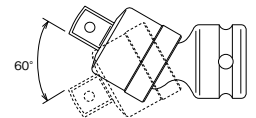

Item Code	Part No.	L (mm)	(g)	(pcs.)	
503661	KO12770	39	30	10	*1

*1 Pin/O-Ring=1200A/B

12233A Adaptor

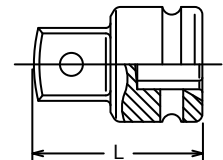

Item Code	Part No.	□ (sq.)	□ (sq.)	L (mm)	(g)	(pcs.)	
806349^	KO12233A	1/4"	3/8"	22	15	10	*1

*1 Pin/O-Ring=1200A/B

FLAT DRIVE®

Flat drive is designed to guarantee a flat surface contact between the socket and the bolt/nut. The Flat contact reduces wear and allows to transmit a higher torque value. The Flat Drive System is also used for the square drive end as well as the hexagonal or bi-hexagonal openings of the socket

3/8" Impact Sockets & Accessories

Z-SERIES

HAND SOCKETS

SCREWDRIVERS

IMPACT

ACCESSORIES

AUTOMOTIVE

RENEWAL KITS

13305M 12-point Sockets, Deep

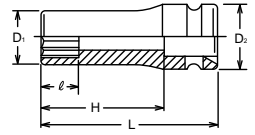

Item Code	Part No.	13305M (mm)	D ₁ (mm)	D ₂ (mm)	ℓ (mm)	H (mm)	L (mm)	(g)	(pcs.)	
806388	KO13305M08	8	13.3	19	8	66.5	80	82	10	*1
806382	KO13305M10	10	15.8	19	10	66.5	80	94	10	*1
806383	KO13305M11	11	17	19	11	66.5	80	110	10	*1
806384	KO13305M12	12	18.3	19	12	66.5	80	111	10	*1
806385	KO13305M13	13	19.5	22	13	66.5	80	138	10	*2
806386	KO13305M14	14	20.8	22	14	66.5	80	148	10	*2
806387	KO13305M17	17	24.5	22	17	65.5	80	168	10	*2

*1 C-Ring=1301C, Pin/O-Ring=1301A/B
*2 C-Ring=1302C, Pin/O-Ring=1302A/B

13365M Pathfinder Sockets deep

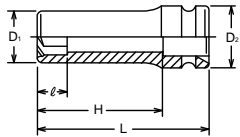

Item Code	Part No.	13365M (mm)	D ₁ (mm)	D ₂ (mm)	ℓ (mm)	H (mm)	L (mm)	(g)	(pcs.)	
806400^	KO13365M08	8	13.3	19	7	66.5	80	90	10	*1
806390^	KO13365M10	10	15.8	19	8	66.5	80	99	10	*1
806391^	KO13365M11	11	17	19	8	66.5	80	108	10	*1
806392^	KO13365M12	12	18.3	19	9	66.5	80	110	10	*1
806393^	KO13365M13	13	19.5	22	9	66.5	80	142	10	*2
806394^	KO13365M14	14	20.8	22	11	66.5	80	144	10	*2
806395^	KO13365M15	15	22	22	11	65.5	80	150	10	*2
806396^	KO13365M16	16	23.3	22	11	65.5	80	159	10	*2
806397^	KO13365M17	17	24.5	22	12	65.5	80	170	10	*2
806398^	KO13365M18	18	25.8	22	13	64.5	80	201	10	*2
806399^	KO13365M19	19	27	22	13	64.5	80	203	10	*2

*1 C-Ring=1301C, Pin/O-Ring=1301A/B
*2 C-Ring=1302C, Pin/O-Ring=1302A/B

13134 Impact Bit Holder

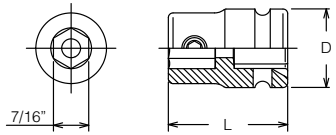

Item Code	Part No.	D (mm)	L (mm)	(g)	(pcs.)	
806380^	KO13134	22	32	70	10	*1

*1 C-Ring=1302C, Pin/O-Ring=1302A/B

 Replacement Screw : M8x5, ●4mm

For DIN3126 E11.2 Bits

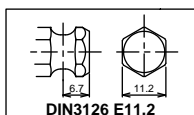

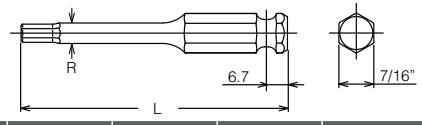

183H-35 Hex Bits

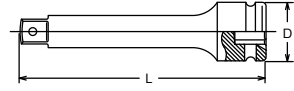

Item Code	Part No.	183H.35 (mm)	L (mm)	(g)	(pcs.)	
806718^	KO183H35M05	5	35	15	10	
806719^	KO183H35M06	6	35	18	10	
806720^	KO183H35M08	8	35	20	10	
806717^	KO183H35M10	10	35	26	10	

13760 Extension Bars



Item Code	Part No.	D (mm)	L (mm)	(g)	(pcs.)	
503731^	KO13760075	22	75	95	10	*1
503732^	KO13760100	22	100	120	10	*1
503733	KO13760125	22	125	141	5	*1
503734^	KO13760150	22	150	165	5	*1
806434^	KO13760200	22	200	210	5	*1
503735^	KO13760225	22	225	260	5	*1
807347^	KO13760250	22	250	260	5	*1

*1 C-Ring=1302C, Pin/O-Ring=1302A/B

13770 Universal Joint

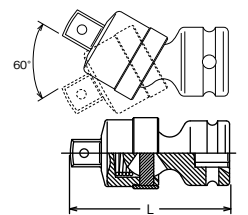

Item Code	Part No.	L (mm)	(g)	(pcs.)	
503736	KO13770	56	110	10	*1
503737^	KO13770P	56	110	10	*1

*1 C-Ring=1302C, Pin/O-Ring=1302A/B

13771 Universal Joint

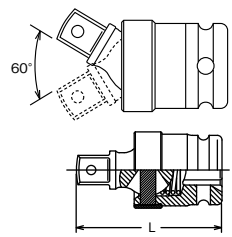

Item Code	Part No.	L (mm)	(g)	(pcs.)	
503739	KO13771	48	92	10	*1

*1 C-Ring=1302C, Pin/O-Ring=1302A/B

13772-P Universal Double Joint

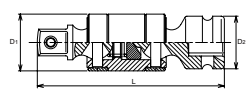

Item Code	Part No.	D ₁ (mm)	D ₂ (mm)	L (mm)	(g)	(pcs.)	
806435	KO13772P	22	19	75	120	5	*1

*1 C-Ring=1301C, Pin/O-Ring=1301A/B

3/8" Impact Sockets & Accessories

13322A Adaptor



Item Code	Part No.	□ (sq.)	□ (sq.)	L (mm)	(g)	(pcs.)	⚡
806389^	KO13322A	3/8"	1/4"	27	25	10	*1

*1 C-Ring=1302C, Pin/O-Ring=1302A/B

 Adapting down from bigger square drive to smaller square drive may lead to excessive torque load and possibly cause breakage. Always stay within safe torque of the smaller square drive.

13344A Adaptor



Item Code	Part No.	□ (sq.)	□ (sq.)	L (mm)	(g)	(pcs.)	⚡
503699	KO13344A	3/8"	1/2"	32.5	53	10	*1

*1 C-Ring=1302C, Pin/O-Ring=1302A/B

13241M Socket Set



METAL CASE:
W240xH30xT35mm

 = 850g

Item Code	Part No.	Sockets
503669^	KO13241M	13400M 6-pt. Sockets 11 Piece Set 9, 10, 11, 12, 13, 14, 15, 16, 17, 18, 19

1301A Spare Pin

1302A



Item Code	Part No.	□	Opening (mm)	D ₁ (mm)	ℓ (mm)	(pcs.)
503663	KO1301A	3/8"	≤ 12	2.5	14.5	10
503666	KO1302A	3/8"	> 12	2.5	17.5	10

1301B Spare Ring

1302B



Item Code	Part No.	□	Opening (mm)	D ₂ (mm)	D ₃ (mm)	(pcs.)
503664	KO1301B	3/8"	≤ 12	3.5	13	10
503667	KO1302B	3/8"	> 12	3.5	16	10

1301C C-Ring

1302C

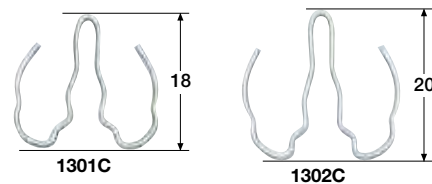

Item Code	Part No.	□	Opening (mm)	(pcs.)
503665	KO1301C	3/8"	≤ 12	10
503668	KO1302C	3/8"	> 12	10



One Piece solid springs steel ring.
Simply set by finger pushing and easily removed by puller. Much more convenient and safer than combination of pin and o-ring.

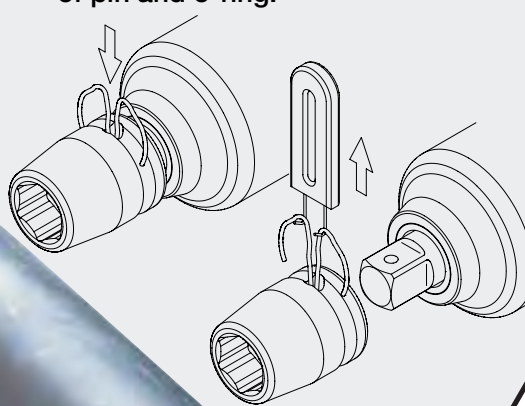



SCAN TO WATCH C-RING VIDEO

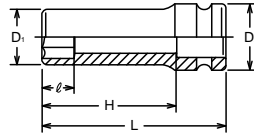

1/2" Impact Sockets & Accessories

14300M • 14300A 6-point Deep Sockets



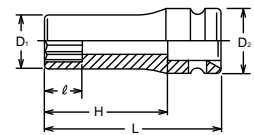

14305M 12-point Deep Sockets





Item Code	Part No.	14300M (mm)	D ₁ (mm)	D ₂ (mm)	ℓ (mm)	H (mm)	L (mm)			
503792	KO14300M08	8	14.5	25	8	62	80	137	10	*1
503793	KO14300M09	9	15.7	25	9	62	80	138	10	*1
503794	KO14300M10	10	17	25	10	62	80	140	10	*1
503795	KO14300M11	11	18.2	25	11	62	80	156	10	*1
503796	KO14300M12	12	19.5	25	12	62	80	162	10	*1
503797	KO14300M13	13	20.7	25	13	62	80	162	10	*1
503798	KO14300M14	14	22	25	14	62	80	174	10	*1
503799	KO14300M15	15	23.2	30	15	62	80	220	10	*2
503800	KO14300M16	16	24.5	30	16	62	80	232	10	*2
503801	KO14300M17	17	25.7	30	17	62	80	232	10	*2
503802	KO14300M18	18	27	30	18	62	80	232	10	*2
503803	KO14300M19	19	28.2	30	19	61	80	240	10	*2
806452	KO14300M20	20	29.5	30	20	61	80	265	10	*2
503804	KO14300M21	21	30.7	30	21	61	80	265	10	*2
503805	KO14300M22	22	32	30	22	65	85	290	10	*2
503806	KO14300M23	23	33.2	30	23	65	85	300	10	*2
503807	KO14300M24	24	34.5	30	24	65	85	329	10	*2
806453	KO14300M25	25	35.7	30	25	65	85	345	10	*2
503808	KO14300M26	26	37	30	26	64	85	350	10	*2
503809	KO14300M27	27	38.2	30	27	64	85	385	10	*2
806454	KO14300M28	28	39.5	30	28	64	85	390	10	*2
503810	KO14300M29	29	40.7	30	29	63	85	416	10	*2
503811	KO14300M30	30	42	30	30	63	85	457	10	*2
503812	KO14300M31	31	43.2	30	31	63	85	505	10	*2
503813	KO14300M32	32	44.5	30	32	63	85	542	10	*2
806455	KO14300M33	33	45.7	30	33	62	85	562	2	*2
503814	KO14300M34	34	47	30	33	62	85	570	2	*2
806456	KO14300M35	35	48.2	30	35	62	85	600	2	*2
503815	KO14300M36	36	49.5	30	36	61	85	635	2	*2
806457	KO14300M38	38	52	30	38	60	85	655	2	*2
503816	KO14300M41	41	55.7	30	38	60	85	686	2	*2

*1 C-Ring=1401C, Pin/O-Ring=1401A/B
*2 C-Ring=1402C, Pin/O-Ring=1402A/B

Item Code	Part No.	14305M (mm)	D ₁ (mm)	D ₂ (mm)	ℓ (mm)	H (mm)	L (mm)			
806478	KO14305M08	8	14.5	25	8	62	80	137	10	*1
806459	KO14305M10	10	17	25	10	62	80	140	10	*1
806460	KO14305M11	11	18.2	25	11	62	80	156	10	*1
806461	KO14305M12	12	19.5	25	12	62	80	162	10	*1
806462	KO14305M13	13	20.7	25	13	62	80	162	10	*1
806463	KO14305M14	14	22	25	14	62	80	174	10	*1
806464	KO14305M15	15	23.2	30	15	62	80	220	10	*2
806465	KO14305M16	16	24.5	30	16	62	80	232	10	*2
807098	KO14305M17	17	25.7	30	17	62	80	232	10	*2
806466	KO14305M18	18	27	30	18	62	80	232	10	*2
806467	KO14305M19	19	28.2	30	19	61	80	259	10	*2
806468	KO14305M20	20	29.5	30	20	61	80	265	10	*2
806469	KO14305M21	21	30.7	30	21	61	80	265	10	*2
806470	KO14305M22	22	32	30	22	65	85	290	10	*2
806471	KO14305M23	23	33.2	30	23	65	85	300	10	*2
806472	KO14305M24	24	34.5	30	24	65	85	329	10	*2
806473	KO14305M26	26	37	30	26	64	85	350	10	*2
806474	KO14305M27	27	38.2	30	27	64	85	385	10	*2
806475	KO14305M28	28	39.5	30	28	64	85	390	10	*2
806476	KO14305M29	29	40.7	30	29	63	85	416	10	*2
503818	KO14305M30	30	42	30	30	63	85	457	10	*2
503819	KO14305M32	32	44.5	30	32	63	85	542	10	*2
806477	KO14305M33	33	45.7	30	33	62	85	562	2	*2
503820	KO14305M36	36	49.5	30	36	61	85	635	2	*2

*1 C-Ring=1401C, Pin/O-Ring=1401A/B
*2 C-Ring=1402C, Pin/O-Ring=1402A/B

Item Code	Part No.	14300A (inch)	D ₁ (mm)	D ₂ (mm)	ℓ (mm)	H (mm)	L (mm)			
503777	KO14300A10	5/16	14.5	25	8	62	80	137	10	*1
503778	KO14300A12	3/8	17	25	10	62	80	140	10	*1
503779	KO14300A14	7/16	18.2	25	11	62	80	156	10	*1
503780	KO14300A16	1/2	20.7	25	13	62	80	162	10	*1
503781	KO14300A18	9/16	22	25	14	62	80	174	10	*1
503782	KO14300A20	5/8	24.5	30	16	62	80	232	10	*2
503783	KO14300A22	11/16	25.7	30	17	62	80	232	10	*2
503784	KO14300A24	3/4	28.2	30	19	61	80	259	10	*2
503785	KO14300A26	13/16	30.7	30	21	61	80	265	10	*2
503786	KO14300A28	7/8	32	30	22	65	85	290	10	*2
503787	KO14300A30	15/16	34.5	30	24	65	85	329	10	*2
503788	KO14300A32	1	35.7	30	25	65	85	345	10	*2
503789	KO14300A34	1. 1/16	38.2	30	27	64	85	385	10	*2
503790	KO14300A36	1. 1/8	40.7	30	29	63	85	416	10	*2
503791	KO14300A40	1. 1/4	44.5	30	32	63	85	542	10	*2
806450	KO14300A46	1. 7/16	50.7	30	37	61	85	580	2	*2
806451	KO14300A48	1. 1/2	52	30	38	61	85	600	2	*2

*1 C-Ring=1401C, Pin/O-Ring=1401A/B
*2 C-Ring=1402C, Pin/O-Ring=1402A/B

Z-SERIES

HAND SOCKETS

SCREWDRIVERS

IMPACT

ACCESSORIES

AUTOMOTIVE

RENEWAL KITS

1/2" Impact Sockets & Accessories

Z-SERIES



PATHFINDER®

The beveled flats of the 6-point opening of the PATHFINDER socket engage the nut almost immediately. PATHFINDER sockets are ideal for use with power tools in automatic assembly processes, as the power tool does not have to be totally stopped for the socket to engage the nut.

HAND SOCKETS

14465M Pathfinder Sockets

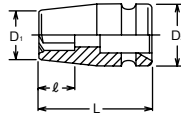

Item Code	Part No.	14465M (mm)	D ₁ (mm)	D ₂ (mm)	ℓ (mm)	L (mm)	(g)	(pcs.)	Ⓢ
806533 [^]	KO14465M10	10	17	25	8	38	89	10	*1
806534 [^]	KO14465M11	11	18.2	25	8	38	87	10	*1
806535 [^]	KO14465M12	12	19.5	25	9	38	87	10	*1
806536 [^]	KO14465M13	13	20.7	25	9	38	86	10	*1
806537 [^]	KO14465M14	14	22	25	11	38	86	10	*1
806538 [^]	KO14465M15	15	23.2	30	11	38	131	10	*2
806539 [^]	KO14465M16	16	24.5	30	11	38	131	10	*2
806540 [^]	KO14465M17	17	25.7	30	12	38	132	10	*2
806541 [^]	KO14465M18	18	27	30	13	38	128	10	*2
806542 [^]	KO14465M20	20	29.5	30	14	38	125	10	*2
806543 [^]	KO14465M21	21	30.7	30	14	38	128	10	*2
806544 [^]	KO14465M22	22	32	30	15	38	130	10	*2
806545 [^]	KO14465M23	23	33.2	30	15	38	135	10	*2
806546 [^]	KO14465M24	24	34.5	30	15	38	135	10	*2
806547 [^]	KO14465M26	26	37	30	15	38	152	10	*2
806548 [^]	KO14465M27	27	38.2	30	16	40	169	10	*2

*1 C-Ring=1401C, Pin/O-Ring=1401A/B
*2 C-Ring=1402C, Pin/O-Ring=1402A/B

SCREWDRIVERS

14025-60 TORX® Bit Sockets

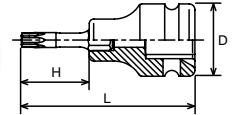

Item Code	Part No.	14025.60 (T)	D (mm)	H (mm)	L (mm)	(g)	(pcs.)	Ⓢ
807099 [^]	KO14025T20	T20	25	23.5	60	75	10	*1
807100 [^]	KO14025T25	T25	25	23.5	60	75	10	*1
806445 [^]	KO14025T27	T27	25	23.5	60	75	10	*1
807101 [^]	KO14025T30	T30	25	23.5	60	80	10	*1
807102 [^]	KO14025T40	T40	25	23.5	60	85	10	*1
806446 [^]	KO14025T45	T45	25	23.5	60	85	10	*1
807103 [^]	KO14025T50	T50	25	23.5	60	95	10	*1
807104 [^]	KO14025T55	T55	25	23.5	60	110	10	*1
807105 [^]	KO14025T60	T60	30	23.5	60	160	10	*2

*1 C-Ring=1401C, Pin/O-Ring=1401A/B
*2 C-Ring=1402C, Pin/O-Ring=1402A/B

IMPACT

14365M Pathfinder Sockets, Deep

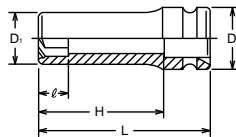

Item Code	Part No.	14365M (mm)	D ₁ (mm)	D ₂ (mm)	ℓ (mm)	H (mm)	L (mm)	(g)	(pcs.)	Ⓢ
806479 [^]	KO14365M10	10	17	25	8	62	80	138	10	*1
505710 [^]	KO14365M11	11	18.2	25	8	62	80	144	10	*1
806480 [^]	KO14365M12	12	19.5	25	9	62	80	165	10	*1
806481 [^]	KO14365M13	13	20.7	25	9	62	80	170	10	*1
806482 [^]	KO14365M14	14	22	25	11	62	80	178	10	*1
505711 [^]	KO14365M15	15	23.2	30	11	62	80	237	10	*2
505712 [^]	KO14365M16	16	24.5	30	11	62	80	245	10	*2
505713 [^]	KO14365M17	17	25.7	30	12	62	80	263	10	*2
505714 [^]	KO14365M18	18	27	30	13	62	80	268	10	*2
505715 [^]	KO14365M19	19	28.2	30	13	61	80	270	10	*2
505716 [^]	KO14365M20	20	29.5	30	14	61	80	274	10	*2
505717 [^]	KO14365M21	21	30.7	30	14	61	80	287	10	*2
505718 [^]	KO14365M22	22	32	30	15	65	85	314	10	*2
505719 [^]	KO14365M23	23	33.2	30	15	65	85	320	10	*2
505720 [^]	KO14365M24	24	34.5	30	15	65	85	335	10	*2
505721 [^]	KO14365M26	26	37	30	15	64	85	388	10	*2
505722 [^]	KO14365M27	27	38.2	30	16	64	85	407	10	*2

*1 C-Ring=1401C, Pin/O-Ring=1401A/B
*2 C-Ring=1402C, Pin/O-Ring=1402A/B

ACCESSORIES

14012M-60 Inhex Sockets

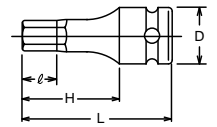

Item Code	Part No.	14012M.60 (mm)	D (mm)	ℓ (mm)	H (mm)	L (mm)	(g)	(pcs.)	Ⓢ
806440 [^]	KO14012M6004	4	25	15.5	38	60	68	10	*1
806441 [^]	KO14012M6005	5	25	15.5	38	60	71	10	*1
503740 [^]	KO14012M6006	6	25	15.5	38	60	74	10	*1
806443 [^]	KO14012M6007	7	25	15.5	38	60	80	10	*1
806444 [^]	KO14012M6008	8	25	15.5	38	60	84	10	*1
806436 [^]	KO14012M6010	10	30	15.5	38	60	140	10	*2
503741 [^]	KO14012M6012	12	30	15.5	38	60	150	10	*2
806437 [^]	KO14012M6014	14	30	15.5	38	60	170	10	*2
806438 [^]	KO14012M6017	17	30	15.5	38	60	190	10	*2
806439 [^]	KO14012M6019	19	30	15.5	38	60	210	10	*2

*1 C-Ring=1401C, Pin/O-Ring=1401A/B
*2 C-Ring=1402C, Pin/O-Ring=1402A/B

AUTOMOTIVE

RS14012M60/10 Inhex Socket Set on Rail





Item Code	Part No.	Socket Set	(g)
505541 [^]	KORS14012M60/10	RS14012A: 10 Piece Set/Rail 300mm 4, 5, 6, 7, 8, 10, 12, 14, 17, 19mm	1,300

RENEWAL KITS

1/2" Impact Sockets & Accessories

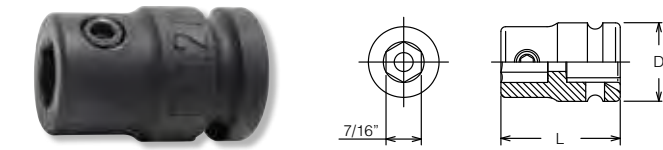

14134 Impact Bit Holder

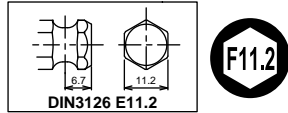

 Replacement Screw : M8x5, ●4mm

For DIN3126 E11.2 Bits





Item Code	Part No.	D (mm)	L (mm)	 (g)	 (pcs.)	
503759^	KO14134	25	38	90	10	*1

*1 C-Ring=1402C, Pin/O-Ring=1402A/B

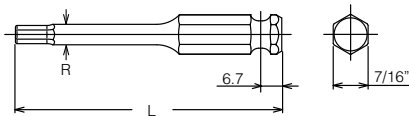

183H-35 Hex Bits

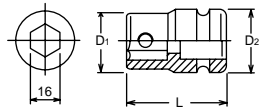

Item Code	Part No.	183H.35 (mm)	L (mm)	 (g)	 (pcs.)
806718^	KO183H35M05	5	35	15	10
806719^	KO183H35M06	6	35	18	10
806720^	KO183H35M08	8	35	20	10
806717^	KO183H35M10	10	35	26	10

14106 Bit Holder for 107-16





Item Code	Part No.	D1 (mm)	D2 (mm)	L (mm)	 (g)	 (pcs.)	
806447^	KO14106	28	30	43	160	10	*1



*1 C-Ring=1402C, Pin/O-Ring=1402A/B

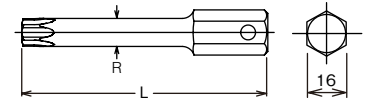

 Replacement Screw : M6x8, ●3mm

107-16 Bits for Inhex screws





Item Code	Part No.	107.16 (mm)	L (mm)	 (g)	 (pcs.)
503631^	KO10716M10	10	40	46	10
503632^	KO10716M12	12	40	52	10
806290^	KO10716M13	13	40	56	10
503633^	KO10716M14	14	40	60	10
806292^	KO10716M16	16	40	69	10
503634^	KO10716M17	17	40	73	10
806294^	KO10716M18	18	40	78	10
503635^	KO10716M19	19	40	80	10
503636^	KO10716M22	22	40	97	10

Item Code	Part No.	107.16 (inch)	L (mm)	 (g)	 (pcs.)
806283^	KO10716A-12	3/8	40	45	10
806284^	KO10716A-16	1/2	40	56	10
806285^	KO10716A-18	9/16	40	60	10
806286^	KO10716A-23	5/8	40	69	10
806287^	KO10716A-24	3/4	40	80	10

Item Code	Part No.	107.16(L100) (mm)	L (mm)	R (mm)	 (g)	 (pcs.)
806288^	KO10716M10(L100)	10	100	13	122	10
806289^	KO10716M12(L100)	12	100	15	146	10
806291^	KO10716M14(L100)	14	100	-	166	10
806293^	KO10716M17(L100)	17	100	-	193	10
806295^	KO10716M19(L100)	19	100	-	232	10
806296^	KO10716M22(L100)	22	100	-	254	10

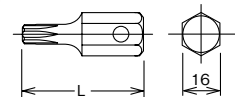
107-16 (T) TORX® Bits



Item Code	Part No.	107.16 (T)	L (mm)	 (g)	 (pcs.)
503637^	KO10716T55	T55	50	57	10
503638^	KO10716T60	T60	50	64	10
503639^	KO10716T70	T70	50	73	10

1/2" Impact Sockets & Accessories

Z-SERIES

107-16 (IP) TORXPLUS® Bits

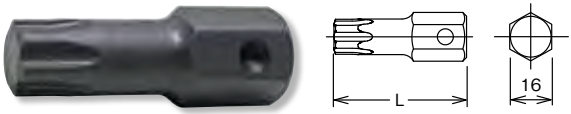

Item Code	Part No.	107.16 (IP)	L (mm)	(g)	(pcs.)
806280^	KO10716-55IP	55IP	50	57	10
806281^	KO10716-60IP	60IP	50	64	10
806282^	KO10716-70IP	70IP	50	73	10

HAND SOCKETS

14760 Extension Bars

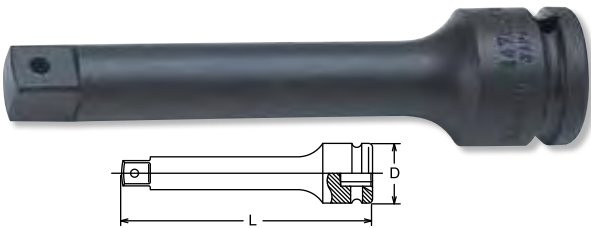

Item Code	Part No.	D (mm)	L (mm)	(g)	(pce.)	(V)
503874^	KO14760050	30	50	150	1	*1
503875^	KO14760075	30	75	188	1	*1
806549^	KO14760100	30	100	240	1	*1
503876^	KO14760125	30	125	275	1	*1
503877^	KO14760150	30	150	300	1	*1
807084^	KO14760200	30	200	358	1	*1
503878^	KO14760225	30	225	440	1	*1
503879^	KO14760250	30	250	480	1	*1

*1 C-Ring=1401C, Pin/O-Ring=1401A/B

SCREWDRIVERS

IMPACT

ACCESSORIES

AUTOMOTIVE

RENEWAL KITS

14770 Universal Joint

14770-B Universal Joint - Ball Type



Item Code	Part No.	L (mm)	(g)	(pcs.)	(V)
503880	KO14770	74	210	5	*1
503881	KO14770-B	74	210	5	*1

*1 C-Ring=1401C, Pin/O-Ring=1401A/B

14771 Universal Joint



Item Code	Part No.	L (mm)	(g)	(pcs.)	(V)
806550^	KO14771	65	198	5	*1

*1 C-Ring=1401C, Pin/O-Ring=1401A/B

14772-P Universal Double Joint

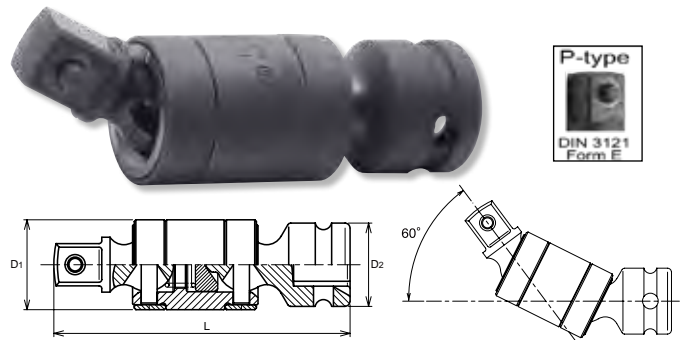

Item Code	Part No.	D ₁ (mm)	D ₂ (mm)	L (mm)	(g)	(pcs.)	(V)
503883	KO14772-P	27	25	90	230	5	*1

*1 C-Ring=1401C, Pin/O-Ring=1401A/B



14433A Adaptor ⚠



Item Code	Part No.	(sq.)	(sq.)	L (mm)	(g)	(pcs.)	(V)
503868	KO14433A	1/2"	3/8"	37.5	68	10	*1
503869^	KO14433A-B	1/2"	3/8"	37.5	68	10	*1

*1 C-Ring=1401C, Pin/O-Ring=1401A/B

⚠ Adapting down to a smaller square drive may lead to excessive torque load and possibly cause breakage. Always stay within limit torque of the smaller square drive.

14466A Adaptor

14466A-B Adaptor - Ball Type



Item Code	Part No.	(sq.)	(sq.)	L (mm)	(g)	(pcs.)	(V)
503871	KO14466A	1/2"	3/4"	44	146	10	*1
503872	KO14466A-B	1/2"	3/4"	44	146	10	*1





*1 C-Ring=1402C, Pin/O-Ring=1402A/B

1/2" Impact Sockets & Accessories

14209M Socket Set



10 Piece Set
METAL CASE: W190xH59xT45mm Δ = 830g

Item Code	Part No.	Bits	Bit Holder
503771	KO14209M	 183H.35 Hex Bits 5, 6, 8, 10	 14134 Bit Holder
		 107.16 Hex Bits 12, 14, 17, 19	 14106 Bit Holder

14208M Socket Set



13 Piece Set
METAL CASE: W395xH90xT50mm Δ = 3,500g

Item Code	Part No.	Sockets
503772	KO14208M-6P	 14300M 6-pt Deep Sockets 10, 12, 13, 14, 15, 16, 17, 18, 19, 21, 22, 24, 27

14241M Impact Socket Set

14241A



13 Piece Set
METAL CASE: W196xH100xT45mm Δ = 2,000g

Item Code	Part No.	Sockets
503776	KO14241M	 14400M 6-pt. Sockets 10, 11, 12, 13, 14, 15, 16, 17, 19, 21, 22, 24, 27

12 Piece Set
METAL CASE: W196xH100xT45mm Δ = 1,970g

Item Code	Part No.	Sockets
503775	KO14241A	 14400A 6-pt. Sockets 3/8, 7/16, 1/2, 9/16, 5/8, 11/16, 3/4, 13/16, 7/8, 15/16, 1, 1.1/8"

1401A Spare Pin

1402A

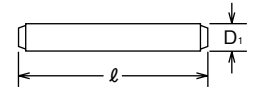

Item Code	Part No.	\square	Opening (mm)	D ₁ (mm)	l (mm)	(pcs.)
503743	KO1401A	1/2"	≤ 14	3.5	20	10
503746	KO1402A	1/2"	> 14	3.5	25	10

1401B Spare Ring

1402B



Item Code	Part No.	\square	Opening (mm)	D ₂ (mm)	D ₃ (mm)	(pcs.)
503744	KO1401B	1/2"	≤ 14	4	19	10
503747	KO1402B	1/2"	> 14	4	24	10

1401C-10 C-Ring 10 Clips + Puller

1402C-10

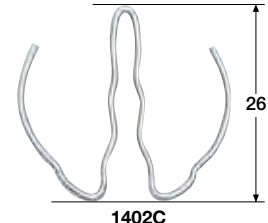
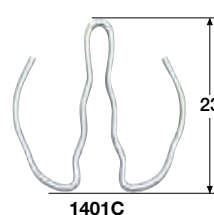

Item Code	Part No.	\square	Opening (mm)	C-Ring 10pcs.	Puller 1pce.
503745	KOPK1401C-10	1/2"	≤ 14	1401C + 149	
503748	KOPK1402C-10	1/2"	> 14	1402C + 149	

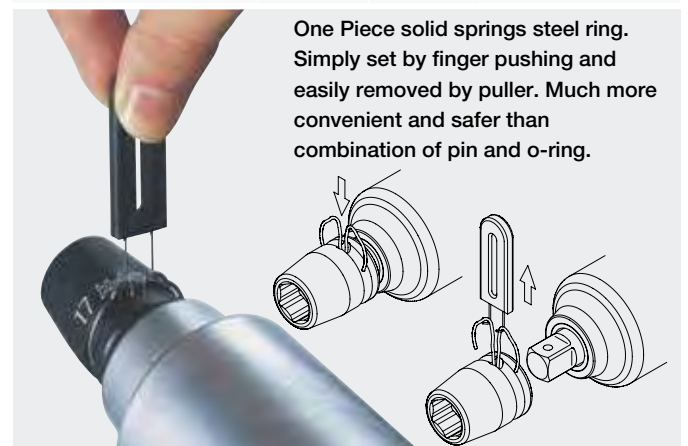

3/4" Impact Sockets & Accessories

16400M

6-point Sockets

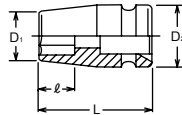

16400A

6-point Sockets

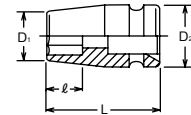

Item Code	Part No.	16400M (mm)	D ₁ (mm)	D ₂ (mm)	ℓ (mm)	L (mm)	(g)	(pcs.)	
504004	KO16400M17	17	30	44	12	50	355	5	*1
504005	KO16400M18	18	31.3	44	13	50	372	5	*1
504006	KO16400M19	19	32.5	44	13	50	360	5	*1
504007	KO16400M20	20	33.8	44	14	50	375	5	*1
504008	KO16400M21	21	35	44	15	50	374	5	*1
504009	KO16400M22	22	36.3	44	15	50	373	5	*1
504010	KO16400M23	23	37.5	44	16	50	373	5	*1
504011	KO16400M24	24	38.8	44	16	50	370	5	*1
504012	KO16400M25	25	40	44	16	50	374	5	*1
504013	KO16400M26	26	41.3	44	16	50	378	5	*1
504014	KO16400M27	27	42.5	44	16	50	375	5	*1
504015	KO16400M28	28	43.8	44	16	50	383	5	*1
504016	KO16400M29	29	45	44	18	53	412	5	*1
504017	KO16400M30	30	46.3	44	18	53	410	5	*1
504018	KO16400M31	31	47.5	44	18	53	426	5	*1
504019	KO16400M32	32	48.8	44	19	53	428	5	*1
504020	KO16400M33	33	50	44	20	55	470	5	*1
504021	KO16400M34	34	51.3	44	20	55	490	5	*1
504022	KO16400M35	35	52.5	44	20	55	494	5	*1
504023	KO16400M36	36	53.8	44	20	55	498	5	*1
505791	KO16400M37	37	55	44	20	55	526	2	*1
504024	KO16400M38	38	56.3	44	20	57	558	2	*1
806612	KO16400M39	39	57.5	44	20	57	579	2	*1
505792	KO16400M40	40	58.8	44	20	57	598	2	*1
504025	KO16400M41	41	60	44	22	57	572	2	*1
504026	KO16400M42	42	61.3	44	22	57	617	2	*1
505793	KO16400M43	43	62.5	44	23	62	720	2	*1
505794	KO16400M44	44	63.8	44	23	62	761	2	*1
505795	KO16400M45	45	65	44	23	62	757	2	*1
504027	KO16400M46	46	66.3	44	23	62	755	2	*1
505796	KO16400M47	47	67.5	54	23	62	805	2	*2
505797	KO16400M48	48	68.8	54	23	62	940	2	*2
806613	KO16400M49	49	70	54	23	62	912	2	*2
504028	KO16400M50	50	71.3	54	30	62	930	2	*2
505798	KO16400M52	52	73.8	54	29	62	1011	2	*2
504029	KO16400M54	54	76.3	54	29	62	1035	2	*2
504030	KO16400M55	55	77.5	54	29	62	1056	2	*2
504031	KO16400M56	56	78.8	54	29	62	1091	2	*2
505800	KO16400M57	57	80	54	32	65	1126	2	*2
504032	KO16400M58	58	81.3	54	31	65	1163	2	*2
806614	KO16400M59	59	82.5	54	31	65	1185	2	*2
504033	KO16400M60	60	83.8	54	31	65	1215	2	*2
806615	KO16400M65	65	90	54	30	65	1325	2	*2
806616	KO16400M70	70	96.3	54	34	70	1570	1	*2

*1 C-Ring=1600C, Pin/O-Ring=1601A/B
*2 C-Ring=1801C

Item Code	Part No.	16400A (inch)	D ₁ (mm)	D ₂ (mm)	ℓ (mm)	L (mm)	(g)	(pcs.)	
503976	KO16400A22	11/16	30	44	12	50	355	5	*1
503977	KO16400A24	3/4	32.5	44	13	50	360	5	*1
503978	KO16400A26	13/16	35	44	15	50	374	5	*1
503979	KO16400A28	7/8	36.3	44	15	50	373	5	*1
503980	KO16400A30	15/16	38.8	44	16	50	370	5	*1
503981	KO16400A32	1	40	44	16	50	374	5	*1
503982	KO16400A34	1. 1/16	42.5	44	16	50	375	5	*1
503983	KO16400A36	1. 1/8	45	44	18	53	412	5	*1
503984	KO16400A38	1. 3/16	46.3	44	18	53	410	5	*1
503985	KO16400A40	1. 1/4	48.8	44	19	53	428	5	*1
503986	KO16400A42	1. 5/16	51.3	44	20	55	490	5	*1
503987	KO16400A44	1. 3/8	52.5	44	20	55	494	5	*1
503988	KO16400A46	1. 7/16	55	44	20	55	526	2	*1
503989	KO16400A48	1. 1/2	56.3	44	20	57	558	2	*1
503990	KO16400A50	1. 9/16	58.8	44	20	57	598	2	*1
503991	KO16400A52	1. 5/8	60	44	22	57	572	2	*1
503992	KO16400A54	1.11/16	62.5	44	23	62	720	2	*1
503993	KO16400A56	1. 3/4	65	44	23	62	757	2	*1
503994	KO16400A58	1.13/16	66.3	44	23	62	755	2	*1
503995	KO16400A60	1. 7/8	68.8	54	23	62	940	2	*2
503996	KO16400A62	1.15/16	70	54	23	62	912	2	*2
503997	KO16400A64	2	72.5	54	30	62	969	2	*2
503998	KO16400A66	2. 1/16	73.8	54	29	62	1011	2	*2
503999	KO16400A68	2. 1/8	76.3	54	29	62	1035	2	*2
504000	KO16400A70	2. 3/16	77.5	54	29	62	1056	2	*2
504001	KO16400A72	2. 1/4	80	54	32	65	1126	2	*2
504002	KO16400A74	2. 5/16	81.3	54	31	65	1163	2	*2
504003	KO16400A76	2. 3/8	83.8	54	31	65	1215	2	*2

*1 C-Ring=1600C, Pin/O-Ring=1601A/B
*2 C-Ring=1801C

3/4" Impact Sockets & Accessories

Z-SERIES
HAND SOCKETS
SCREWDRIERS
IMPACT
ACCESSORIES
AUTOMOTIVE
RENEWAL KITS

16301M

6-point Deep Sockets,
Thin Walled

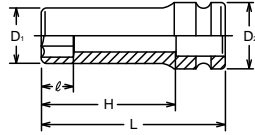

16305M

12-point Sockets, Deep

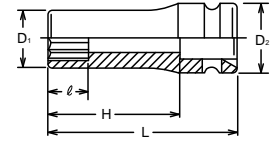

Item Code	Part No.	16301M (mm)	D ₁ (mm)	D ₂ (mm)	ℓ (mm)	H (mm)	L (mm)	(g)	(pcs.)	
807133 [^]	KO16301M16	16	26.8	43	16	74	100	435	2	*1
503961 [^]	KO16301M17	17	28	43	17	74	100	470	2	*1
807134 [^]	KO16301M18	18	29.3	43	18	74	100	475	2	*1
505787 [^]	KO16301M29	19	30.5	43	19	74	100	480	2	*1
806572 [^]	KO16301M20	20	31.8	43	20	74	100	491	2	*1
806573 [^]	KO16301M21	21	33	43	21	74	100	505	2	*1
806574 [^]	KO16301M22	22	34.3	43	22	74	100	528	2	*1
806575 [^]	KO16301M23	23	35.5	43	23	74	100	542	2	*1
503962 [^]	KO16301M24	24	36.8	43	24	74	100	560	2	*1
806577 [^]	KO16301M25	25	38	43	25	74	100	581	2	*1
806578 [^]	KO16301M26	26	39.3	43	26	74	100	600	2	*1
503963 [^]	KO16301M27	27	40.5	43	27	73	100	610	2	*1
806580 [^]	KO16301M28	28	41.8	43	28	73	100	639	2	*1
806581 [^]	KO16301M29	29	43	43	29	73	100	650	2	*1
503964 [^]	KO16301M30	30	44.3	43	30	73	100	670	2	*1
806582 [^]	KO16301M31	31	45.5	43	31	72	100	690	2	*1
503965 [^]	KO16301M32	32	46.8	43	32	72	100	715	2	*1
503966 [^]	KO16301M33	33	48	43	33	72	100	730	2	*1
806583 [^]	KO16301M34	34	49.3	43	34	72	100	750	2	*1
806584 [^]	KO16301M35	35	50.5	43	35	71	100	785	2	*1
900023 [^]	KO16301M36	36	51.8	43	36	71	100	830	2	*1
806586 [^]	KO16301M37	37	53	43	37	71	100	850	2	*1
806587 [^]	KO16301M38	38	54.3	43	38	70	100	885	2	*1
807135 [^]	KO16301M39	39	55.5	43	38	70	100	908	2	*1
807136 [^]	KO16301M40	40	56.8	43	38	70	100	925	2	*1
806588 [^]	KO16301M41	41	58	43	38	69	100	970	2	*1
806589 [^]	KO16301M42	42	59.3	43	38	69	100	990	2	*1
806590 [^]	KO16301M46	46	64.3	43	38	68	100	1150	2	*1
806591 [^]	KO16301M50	50	69.2	53	62	-	100	1328	2	*1

*1 C-Ring=1600C, Pin/O-Ring=1601A/B

Item Code	Part No.	16305M (mm)	D ₁ (mm)	D ₂ (mm)	ℓ (mm)	H (mm)	L (mm)	(g)	(pcs.)	
806592	KO16305M14	14	26.3	44	14	74	100	500	2	*1
806593	KO16305M16	16	28.8	44	16	74	100	522	2	*1
505788	KO16305M17	17	30	44	17	74	100	544	2	*1
806594	KO16305M18	18	31.3	44	18	74	100	600	2	*1
505789	KO16305M19	19	32.5	44	19	74	100	655	2	*1
806595	KO16305M21	21	35	44	21	74	100	700	2	*1
807044	KO16305M22	22	36.3	44	22	74	100	700	2	*1
806596	KO16305M23	23	37.5	44	23	74	100	720	2	*1
806597	KO16305M24	24	38.8	44	24	74	100	715	2	*1
806598	KO16305M26	26	41.3	44	26	74	100	760	2	*1
806599	KO16305M27	27	42.5	44	27	73	100	765	2	*1
806600	KO16305M28	28	43.8	44	28	73	100	800	2	*1
806601	KO16305M29	29	45	44	29	73	100	835	2	*1
806602	KO16305M30	30	46.3	44	30	73	100	840	2	*1
806603	KO16305M32	32	48.8	44	32	72	100	875	2	*1
806604	KO16305M33	33	50	44	33	72	100	920	2	*1
806605	KO16305M34	34	51.3	44	34	72	100	950	2	*1
806606	KO16305M35	35	52.5	44	35	71	100	980	2	*1
806607	KO16305M36	36	53.8	44	36	71	100	960	2	*1
806608	KO16305M38	38	56.3	44	38	70	100	990	2	*1
806609	KO16305M41	41	60	44	38	69	100	1120	2	*1
806610	KO16305M46	46	66.3	44	38	68	100	1305	2	*1
806611	KO16305M50	50	71.3	54	61	-	100	1469	2	*2

*1 C-Ring=1600C, Pin/O-Ring=1601A/B

*2 C-Ring=1801C

16106 Bit Holder, For 107-16

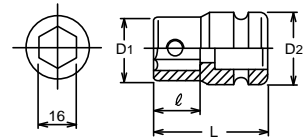

Item Code	Part No.	D ₁ (mm)	D ₂ (mm)	ℓ (mm)	L (mm)	(g)	(pcs.)	
503903 [^]	KO16106	32	44	16	52	370	2	*1

*1 C-Ring=1600C, Pin/O-Ring=1601A/B

 Replacement Screw : M6x10, ●3mm

3/4" Impact Sockets & Accessories

107-16 Bits for Inhex screws

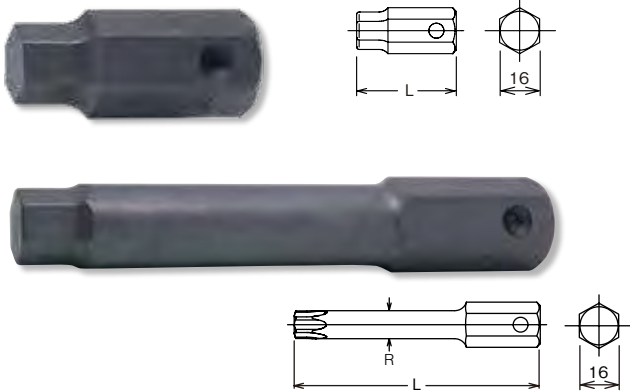

Item Code	Part No.	107.16 (mm)	L (mm)	⚖️ (g)	📦 (pcs.)
503631^	KO10716M10	10	40	46	10
503632^	KO10716M12	12	40	52	10
806290^	KO10716M13	13	40	56	10
503633^	KO10716M14	14	40	60	10
806292^	KO10716M16	16	40	69	10
503634^	KO10716M17	17	40	73	10
806294^	KO10716M18	18	40	78	10
503635^	KO10716M19	19	40	80	10
503636^	KO10716M22	22	40	97	10

Item Code	Part No.	107.16 (inch)	L (mm)	⚖️ (g)	📦 (pcs.)
806283^	KO10716A-12	3/8	40	45	10
806284^	KO10716A-16	1/2	40	56	10
806285^	KO10716A-18	9/16	40	60	10
806286^	KO10716A-23	5/8	40	69	10
806287^	KO10716A-24	3/4	40	80	10

Item Code	Part No.	107.16(L100) (mm)	L (mm)	R (mm)	⚖️ (g)	📦 (pcs.)
806288^	KO10716M10(L100)	10	100	13	122	10
806289^	KO10716M12(L100)	12	100	15	146	10
806291^	KO10716M14(L100)	14	100	-	166	10
806293^	KO10716M17(L100)	17	100	-	193	10
806295^	KO10716M19(L100)	19	100	-	232	10
806296^	KO10716M22(L100)	22	100	-	254	10

107-16 (T) TORX® Bits



Item Code	Part No.	107.16 (T)	L (mm)	⚖️ (g)	📦 (pcs.)
503637^	KO10716T55	T55	50	57	10
503638^	KO10716T60	T60	50	64	10
503639^	KO10716T70	T70	50	73	10

107-16 (IP) TORXPLUS® Bits



Item Code	Part No.	107.16 (IP)	L (mm)	⚖️ (g)	📦 (pcs.)
806280^	KO10716-55IP	55IP	50	57	10
806281^	KO10716-60IP	60IP	50	64	10
806282^	KO10716-70IP	70IP	50	73	10

16204AM Hex Bit Set



9 Piece Set
METAL CASE: W215xH80xT47mm $\text{⚖️} = 1,200\text{g}$

Item Code	Part No.	Bit Holder	Hex Bit - 16H Shank
503914^	KO16204AM	16106	107-16: 12, 14, 17, 19mm 107-16: 1/2, 9/16, 5/8"

16107 Bit Holder



Item Code	Part No.	D ₁ (mm)	D ₂ (mm)	l (mm)	L (mm)	⚖️ (g)	📦 (pcs.)	⚡
503909^	KO16107	44	44	22	60	530	2	*1

*1 C-Ring=1600C, Pin/O-Ring=1601A/B

 Replacement Screw : M8x14, $\text{⚡} 4\text{mm}$

107-22 Bits for Inhex Screws



Item Code	Part No.	107.22 (mm)	L (mm)	⚖️ (g)	📦 (pcs.)
806305^	KO10722M17	17	50	120	10
503640^	KO10722M19	19	50	140	10
503641^	KO10722M22	22	50	162	10
503642^	KO10722M24	24	50	176	10
503643^	KO10722M27	27	50	200	10
806306^	KO10722M30	30	50	227	10
806307^	KO10722M32	32	55	243	10

Item Code	Part No.	107.22 (inch)	L (mm)	⚖️ (g)	📦 (pcs.)
806300^	KO10722A20	5/8	50	120	10
806301^	KO10722A24	3/4	50	140	10
806302^	KO10722A28	7/8	50	162	10
806303^	KO10722A32	1	50	190	10
806304^	KO10722A40	1. 1/4	55	243	10

107-22 (T) TORX® Bits



Item Code	Part No.	107.22 (T)	L (mm)	⚖️ (g)	📦 (pcs.)
503645^	KO10722T80	T 80	60	141	10
503646^	KO10722T90	T 90	60	155	10
503644^	KO10722T100	T100	60	170	10

3/4" Impact Sockets & Accessories

Z-SERIES

16205M

Hex Bit Set



6 Piece Set
METAL CASE: W215xH80xT47mm Δ = 1,650g

Item Code	Part No.	Bit Holder	Hex Bit - 22H Shank
503915	KO16205M	16107	107-22: 17, 19, 22, 24, 27mm

HAND SOCKETS

16760

Extension Bars



Item Code	Part No.	D (mm)	L (mm)	(g)	(pce.)	
511179	KO16760150	44	150	775	1	*1
504043	KO16760175	44	175	870	1	*1
511180	KO16760200	44	200	955	1	*1
504044	KO16760250	44	250	1150	1	*1
504045	KO16760330	44	330	1460	1	*1

*1 C-Ring=1600C, Pin/O-Ring=1601A/B

SCREWDRIVERS

16770

Universal Joint

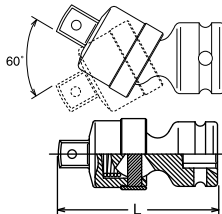

Item Code	Part No.	L (mm)	(g)	(pce.)	
504046	KO16770	106	790	1	*1

*1 C-Ring=1600C, Pin/O-Ring=1601A/B

IMPACT

16771

Universal Joint

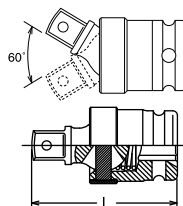

Item Code	Part No.	L (mm)	(g)	(pce.)	
504048^	KO16771	95	720	1	*1

*1 C-Ring=1600C, Pin/O-Ring=1601A/B

ACCESSORIES

AUTOMOTIVE

16644A

Reducer

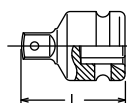

NO WARRANTY

Item Code	Part No.	(sq.)	(sq.)	L (mm)	(g)	(pce.)	
504034	KO16644A	3/4"	1/2"	52	310	1	*1

*1 C-Ring=1600C, Pin/O-Ring=1601A/B

Adapting down to a smaller square drive may lead to excessive torque load and possibly cause breakage. Always stay within limit torque of the smaller square drive.

RENEWAL KITS

16688A

Adaptor

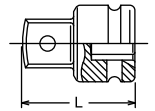

Item Code	Part No.	(sq.)	(sq.)	L (mm)	(g)	(pce.)	
504035	KO16688A	3/4"	1"	62	435	1	*1

*1 C-Ring=1600C, Pin/O-Ring=1601A/B

1601A

Spare Pin

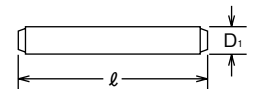

Item Code	Part No.	(sq.)	Opening (mm)	D1 (mm)	l (mm)	(pce.)
503901	KO1601A	3/4"	≤ 46	5.5	35	10

1601B

Spare Ring

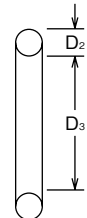

Item Code	Part No.	(sq.)	Opening (mm)	D2 (mm)	D3 (mm)	(pce.)
503902	KO1601B	3/4"	≤ 46	5	36	10

1600C-10

C-Ring 10 Clips + Puller

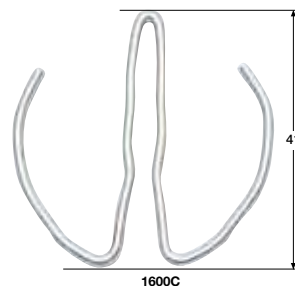

1600C

152

Item Code	Part No.	(sq.)	Opening (mm)	C-Ring 10pcs.	Puller 1pce.
503900	KO1600C-10	3/4"	≤ 46	1600C + 152	

1801C-10

C-Ring 10 Clips + Puller

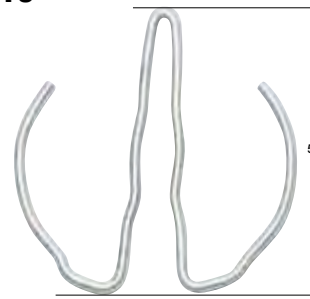

1801C

152

Item Code	Part No.	(sq.)	Opening (mm)	C-Ring 10pcs.	Puller 1pce.
504091	KO1801C-10	1"	≤ 70	1801C + 152	

3/4" Impact Sockets & Accessories

16201M • 16201A  Socket Sets



13 Piece Set
METAL CASE: W320xH110xT70mm  = 6,800g

Item Code	Part No.	Sockets	
806565^	KO16201M		16400M 6-pt. Sockets 19, 21, 22, 23, 24, 26, 27, 30, 32, 33, 36, 38, 41

11 Piece Set
METAL CASE: W320xH110xT70mm  = 6,000g

Item Code	Part No.	Sockets	
806564^	KO16201A		16400A 6-pt. Sockets 3/4, 7/8, 15/16, 1, 1.1/16, 1.1/8, 1.1/4, 1.5/16, 1.3/8, 1.7/16, 1.1/2"

Z-SERIES

HAND SOCKETS

SCREWDRIVERS

IMPACT

ACCESSORIES

AUTOMOTIVE

RENEWAL KITS



One Piece solid springs steel ring.
Simply set by finger pushing and easily removed by puller. Much more convenient and safer than combination of pin and o-ring.



1" Impact Sockets & Accessories

18400M

6-point Sockets

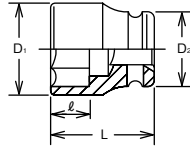

18400A

6-point Sockets

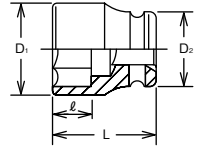

Item Code	Part No.	18400M (mm)	D ₁ (mm)	D ₂ (mm)	ℓ (mm)	L (mm)	⚖️ (g)	📦 (pcs.)	Ⓜ️
505843 [^]	KO18400M19	19	35.3	54	13	57	590	2	*1
504192 [^]	KO18400M21	21	37.8	54	15	57	605	2	*1
504193 [^]	KO18400M22	22	39	54	15	57	620	2	*1
504194 [^]	KO18400M23	23	40.3	54	16	57	615	2	*1
504195 [^]	KO18400M24	24	41.5	54	16	57	627	2	*1
504196 [^]	KO18400M25	25	42.8	54	16	57	620	2	*1
504197 [^]	KO18400M26	26	44	54	16	57	640	2	*1
504198 [^]	KO18400M27	27	45.3	54	16	57	627	2	*1
504199 [^]	KO18400M28	28	46.5	54	16	57	640	2	*1
504200 [^]	KO18400M29	29	47.8	54	18	57	657	2	*1
504201 [^]	KO18400M30	30	49	54	21	62	657	2	*1
504202 [^]	KO18400M31	31	50.3	54	21	62	687	2	*1
504203 [^]	KO18400M32	32	51.5	54	21	62	685	2	*1
504204 [^]	KO18400M33	33	52.8	54	21	62	685	2	*1
504205 [^]	KO18400M34	34	54	54	21	62	690	2	*1
504206 [^]	KO18400M35	35	55.3	54	21	62	710	2	*1
504207 [^]	KO18400M36	36	56.5	54	21	62	712	2	*1
504208 [^]	KO18400M38	38	59	54	25	66	720	2	*1
504209 [^]	KO18400M40	40	61.5	54	25	66	850	2	*1
504210 [^]	KO18400M41	41	62.8	54	25	66	850	2	*1
504211 [^]	KO18400M42	42	64	54	25	66	905	2	*1
505844 [^]	KO18400M43	43	65.3	54	27	68	977	2	*1
505845 [^]	KO18400M44	44	66.5	54	27	68	970	2	*1
504212 [^]	KO18400M45	45	67.8	54	27	68	963	2	*1
504213 [^]	KO18400M46	46	69	54	29	70	1010	2	*1
505846 [^]	KO18400M47	47	70.3	54	36	70	997	2	*1
505847 [^]	KO18400M48	48	71.5	54	35	70	990	2	*1
504214 [^]	KO18400M50	50	74	54	35	70	1065	2	*1
504215 [^]	KO18400M52	52	76.5	54	40	75	1185	2	*1
505848 [^]	KO18400M54	54	79	54	40	75	1252	2	*1
504216 [^]	KO18400M55	55	80.3	54	39	75	1260	2	*1
505849 [^]	KO18400M56	56	81.5	54	39	75	1277	2	*1
505850 [^]	KO18400M58	58	84	54	39	75	1340	2	*1
504217 [^]	KO18400M60	60	86.5	54	39	75	1400	2	*1
504218 [^]	KO18400M63	63	90.3	54	38	75	1383	2	*1
504219 [^]	KO18400M65	65	92.8	54	38	75	1630	2	*1
504220 [^]	KO18400M70	70	99	54	37	75	1625	1	*1
504221 [^]	KO18400M75	75	105.3	86	37	80	2675	1	*2
504222 [^]	KO18400M80	80	111.5	86	41	85	2996	1	*2
504223 [^]	KO18400M85	85	117.8	86	37	90	3378	1	*2
504224 [^]	KO18400M90	90	124	86	40	95	3871	1	*2

*1 C-Ring=1801C, Pin/O-Ring=1801A/B
*2 Pin/O-Ring=1802A/B

Item Code	Part No.	18400A (inch)	D ₁ (mm)	D ₂ (mm)	ℓ (mm)	L (mm)	⚖️ (g)	📦 (pcs.)	Ⓜ️
505842 [^]	KO18400A024	3/4	35.3	54	13	57	590	2	*1
504151 [^]	KO18400A026	13/16	37.8	54	15	57	605	2	*1
504152 [^]	KO18400A028	7/8	39	54	15	57	620	2	*1
504153 [^]	KO18400A030	15/16	41.5	54	16	57	627	2	*1
504154 [^]	KO18400A032	1	42.8	54	16	57	620	2	*1
504155 [^]	KO18400A034	1. 1/16	45.3	54	16	57	627	2	*1
504156 [^]	KO18400A036	1. 1/8	47.8	54	18	57	657	2	*1
504157 [^]	KO18400A038	1. 3/16	49	54	21	62	657	2	*1
504158 [^]	KO18400A040	1. 1/4	51.5	54	21	62	685	2	*1
504159 [^]	KO18400A042	1. 5/16	54	54	21	62	690	2	*1
504160 [^]	KO18400A044	1. 3/8	55.3	54	21	62	710	2	*1
504161 [^]	KO18400A046	1. 7/16	57.8	54	21	62	735	2	*1
504162 [^]	KO18400A048	1. 1/2	59	54	25	66	720	2	*1
504163 [^]	KO18400A050	1. 9/16	61.5	54	25	66	850	2	*1
504164 [^]	KO18400A052	1. 5/8	62.8	54	25	66	850	2	*1
504165 [^]	KO18400A054	1.11/16	65.3	54	27	68	977	2	*1
504166 [^]	KO18400A056	1. 3/4	67.8	54	27	68	963	2	*1
504167 [^]	KO18400A058	1.13/16	69	54	29	70	1010	2	*1
504168 [^]	KO18400A060	1. 7/8	71.5	54	35	70	990	2	*1
504169 [^]	KO18400A062	1.15/16	72.8	54	35	70	1000	2	*1
504170 [^]	KO18400A064	2	75.3	54	35	70	1060	2	*1
504171 [^]	KO18400A066	2. 1/16	76.5	54	40	75	1185	2	*1
504172 [^]	KO18400A068	2. 1/8	79	54	40	75	1252	2	*1
504173 [^]	KO18400A070	2. 3/16	80.3	54	39	75	1260	2	*1
504174 [^]	KO18400A072	2. 1/4	82.8	54	39	75	1337	2	*1
504175 [^]	KO18400A074	2. 5/16	84	54	39	75	1340	2	*1
504176 [^]	KO18400A076	2. 3/8	86.5	54	39	75	1400	2	*1
504177 [^]	KO18400A078	2. 7/16	89	54	38	75	1410	2	*1
504178 [^]	KO18400A080	2. 1/2	91.5	54	38	75	1498	2	*1
504179 [^]	KO18400A082	2. 9/16	92.8	54	38	75	1630	2	*1
504180 [^]	KO18400A084	2. 5/8	95.3	54	38	75	1580	2	*1
504181 [^]	KO18400A086	2.11/16	96.5	54	37	75	1583	1	*1
504182 [^]	KO18400A088	2. 3/4	99	54	37	75	1625	1	*1
504183 [^]	KO18400A090	2.13/16	101.5	86	37	80	2705	1	*2
504184 [^]	KO18400A092	2. 7/8	102.8	86	38	80	2629	1	*2
504185 [^]	KO18400A094	2.15/16	105.3	86	37	80	2675	1	*2
504186 [^]	KO18400A096	3	106.5	86	37	80	2705	1	*2
504187 [^]	KO18400A098	3. 1/16	109	86	42	85	2967	1	*2
504188 [^]	KO18400A100	3. 1/8	111.5	86	41	85	2996	1	*2
504189 [^]	KO18400A104	3. 1/4	115.3	86	44	90	3328	1	*2
504190 [^]	KO18400A108	3. 3/8	119	86	36	90	3389	1	*2
504191 [^]	KO18400A112	3. 1/2	124	86	40	95	3871	1	*2

*1 C-Ring=1801C, Pin/O-Ring=1801A/B
*2 Pin/O-Ring=1802A/B

Z-SERIES

HAND SOCKETS

SCREWDRIVERS

IMPACT

ACCESSORIES

AUTOMOTIVE

RENEWAL KITS

1" Impact Sockets & Accessories

18405M · 18405A ○ 12-point Sockets

18300M ○ 6-point Sockets, deep

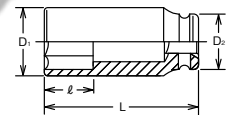
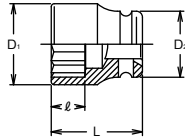

Item Code	Part No.	18405M (mm)	D ₁ (mm)	D ₂ (mm)	ℓ (mm)	L (mm)	(g)	(pcs.)	⊕
806732	KO18405M24	24	41.5	54	16	57	627	2	*1
806733	KO18405M27	27	45.3	54	16	57	607	2	*1
806734	KO18405M30	30	49	54	21	62	657	2	*1
806735	KO18405M32	32	51.5	54	21	62	685	2	*1
806736	KO18405M33	33	52.8	54	21	62	690	2	*1
806737	KO18405M35	35	55.3	54	21	62	690	2	*1
806738	KO18405M36	36	56.5	54	21	62	692	2	*1
806739	KO18405M38	38	59	54	25	66	700	2	*1
806740	KO18405M40	40	61.5	54	25	66	830	2	*1
806741	KO18405M41	41	62.8	54	25	66	905	2	*1
806742	KO18405M46	46	69	54	29	70	990	2	*1
806743	KO18405M50	50	74	54	35	70	1021	2	*1
807047	KO18405M55	55	80.3	54	39	75	1234	2	*1
806744	KO18405M56	56	81.5	54	39	75	1250	2	*1
806745	KO18405M60	60	86.5	54	39	75	1400	2	*1
806746	KO18405M65	65	92.8	54	38	75	1600	2	*1
806747^	KO18405M70	70	99	54	37	75	1625	1	*1
806748^	KO18405M75	75	105.3	86	37	80	2675	1	*2
806749^	KO18405M80	80	111.5	86	41	85	2996	1	*2

*1 C-Ring=1801C, Pin/O-Ring=1801A/B
*2 Pin/O-Ring=1802A/B

Item Code	Part No.	18405A (inch)	D ₁ (mm)	D ₂ (mm)	ℓ (mm)	L (mm)	(g)	(pcs.)	⊕
806721^	KO18405A24	3/4	35.3	54	13	57	590	2	*1
806722^	KO18405A28	7/8	39	54	15	57	620	2	*1
806723^	KO18405A32	1	42.8	54	16	57	620	2	*1
806724^	KO18405A36	1. 1/8	47.8	54	18	57	660	2	*1
806725^	KO18405A38	1. 3/16	49	54	21	62	660	2	*1
806726^	KO18405A40	1. 1/4	51.5	54	21	62	690	2	*1
806727^	KO18405A44	1. 3/8	55.3	54	21	62	710	2	*1
806728^	KO18405A46	1. 7/16	57.8	54	21	62	735	2	*1
806729^	KO18405A48	1. 1/2	59	54	25	66	720	2	*1
806730^	KO18405A56	1. 3/4	67.8	54	27	68	970	2	*1
806731^	KO18405A62	1.15/16	72.8	54	35	70	1000	2	*1

*1 C-Ring=1801C, Pin/O-Ring=1801A/B

Item Code	Part No.	18300M (mm)	D ₁ (mm)	D ₂ (mm)	ℓ (mm)	H (mm)	L (mm)	(g)	(pcs.)	⊕
806712	KO18300M17	17	32.8	54	17	77	108	1000	2	*1
806713	KO18300M19	19	35.3	54	19	77	108	1010	2	*1
806714	KO18300M21	21	37.8	54	21	77	108	1010	2	*1
504125	KO18300M22	22	39	54	22	77	108	1010	2	*1
504126	KO18300M23	23	40.3	54	26	77	108	1063	2	*1
504127	KO18300M24	24	41.5	54	24	77	108	1060	2	*1
504128	KO18300M25	25	42.8	54	25	77	108	1085	2	*1
504129	KO18300M26	26	44	54	26	77	108	1133	2	*1
504130	KO18300M27	27	45.3	54	27	77	108	1125	2	*1
504131	KO18300M28	28	46.5	54	28	77	108	1140	2	*1
504132	KO18300M29	29	47.8	54	29	77	108	1120	2	*1
504133	KO18300M30	30	49	54	30	77	108	1179	2	*1
504134	KO18300M31	31	50.3	54	31	77	108	1125	2	*1
504135	KO18300M32	32	51.5	54	32	77	108	1200	2	*1
504136	KO18300M33	33	52.8	54	33	77	108	1200	2	*1
504137	KO18300M34	34	54	54	34	77	108	1280	2	*1
504138	KO18300M35	35	55.3	54	35	77	108	1300	2	*1
504139	KO18300M36	36	56.5	54	36	76	108	1280	2	*1
504140	KO18300M38	38	59	54	38	76	108	1423	2	*1
504141	KO18300M41	41	62.8	54	38	75	108	1450	2	*1
504142	KO18300M42	42	64	54	38	75	108	1550	2	*1
504143	KO18300M46	46	69	54	38	74	108	1680	2	*1
504144	KO18300M48	48	71.5	54	67	-	108	1500	2	*1
504145	KO18300M50	50	74	54	66	-	108	1650	2	*1
504146	KO18300M52	52	76.5	54	65	-	108	1770	2	*1
504147	KO18300M55	55	80.3	54	63	-	108	1855	2	*1
504148	KO18300M60	60	86.5	54	60	-	108	2047	2	*1
504149	KO18300M65	65	92.8	54	58	-	108	2310	2	*1
504150	KO18300M70	70	99	54	55	-	108	2440	1	*1
505835	KO18300M75	75	105.3	86	52	-	108	3646	1	*2
505836	KO18300M80	80	111.5	86	49	-	108	4039	1	*2
806715^	KO18300M85	85	117.8	86	59	-	108	4000	1	*2
505837	KO18300M90	90	124	86	57	-	108	4200	1	*2
806716^	KO18300M95	95	130.3	86	55	-	108	4400	1	*2

*1 C-Ring=1801C, Pin/O-Ring=1801A/B
*2 Pin/O-Ring=1802A/B

Z-SERIES

HAND SOCKETS

SCREWDRIVERS

IMPACT

ACCESSORIES

AUTOMOTIVE

RENEWAL KITS

1" Impact Sockets & Accessories

Z-SERIES

HAND SOCKETS

SCREWDRIVERS

IMPACT

ACCESSORIES

AUTOMOTIVE

RENEWAL KITS

18300A

6-point Sockets, deep

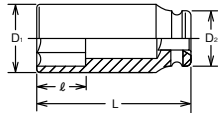

Item Code	Part No.	18300A (inch)	D ₁ (mm)	D ₂ (mm)	ℓ (mm)	H (mm)	L (mm)	(g)	(pcs.)	
504098^	KO18300A28	7/8	39	54	22	77	108	1010	2	*1
504099^	KO18300A30	15/16	41.5	54	24	77	108	1060	2	*1
504100^	KO18300A32	1	42.8	54	25	77	108	1085	2	*1
504101^	KO18300A34	1. 1/16	45.3	54	27	77	108	1125	2	*1
504102^	KO18300A36	1. 1/8	47.8	54	29	77	108	1120	2	*1
504103^	KO18300A38	1. 3/16	49	54	30	77	108	1179	2	*1
504104^	KO18300A40	1. 1/4	51.5	54	32	77	108	1200	2	*1
504105^	KO18300A42	1. 5/16	54	54	34	77	108	1280	2	*1
504106^	KO18300A44	1. 3/8	55.3	54	35	77	108	1300	2	*1
504107^	KO18300A46	1. 7/16	57.8	54	37	76	108	1320	2	*1
504108^	KO18300A48	1. 1/2	59	54	38	76	108	1423	2	*1
504109^	KO18300A50	1. 9/16	61.5	54	38	75	108	1415	2	*1
504110^	KO18300A52	1. 5/8	62.8	54	38	75	108	1450	2	*1
504111^	KO18300A54	1.11/16	65.3	54	38	74	108	1577	2	*1
504112^	KO18300A56	1. 3/4	67.8	54	38	74	108	1660	2	*1
504113^	KO18300A58	1.13/16	69	54	38	74	108	1680	2	*1
504114^	KO18300A60	1. 7/8	71.5	54	67	-	108	1500	2	*1
504115^	KO18300A62	1.15/16	72.8	54	67	-	108	1570	2	*1
504116^	KO18300A64	2	75.3	54	66	-	108	1605	2	*1
504117^	KO18300A66	2. 1/16	76.5	54	65	-	108	1770	2	*1
504118^	KO18300A68	2. 1/8	79	54	64	-	108	1812	2	*1
504119^	KO18300A70	2. 3/16	80.3	54	63	-	108	1855	2	*1
504120^	KO18300A72	2. 1/4	82.8	54	62	-	108	1916	2	*1
504121^	KO18300A74	2. 5/16	84	54	61	-	108	1987	2	*1
504122^	KO18300A76	2. 3/8	86.5	54	60	-	108	2047	2	*1
504123^	KO18300A78	2. 7/16	89	54	59	-	108	2041	2	*1
504124^	KO18300A80	2. 1/2	91.5	54	58	-	108	2250	2	*1
504097^	KO18300A100	3. 1/8	111.5	86	49	-	108	4309	1	*2

*1 C-Ring=1801C, Pin/O-Ring=1801A/B
*2 Pin/O-Ring=1802A/B

107-16

Bits for Inhex screws

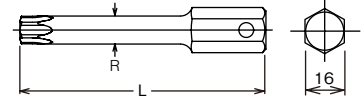
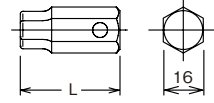

Item Code	Part No.	107.16 (mm)	L (mm)	(g)	(pcs.)
503631^	KO10716M10	10	40	46	10
503632^	KO10716M12	12	40	52	10
806290^	KO10716M13	13	40	56	10
503633^	KO10716M14	14	40	60	10
806292^	KO10716M16	16	40	69	10
503634^	KO10716M17	17	40	73	10
806294^	KO10716M18	18	40	78	10
503635^	KO10716M19	19	40	80	10
503636^	KO10716M22	22	40	97	10

Item Code	Part No.	107.16 (inch)	L (mm)	(g)	(pcs.)
806283^	KO10716A-12	3/8	40	45	10
806284^	KO10716A-16	1/2	40	56	10
806285^	KO10716A-18	9/16	40	60	10
806286^	KO10716A-23	5/8	40	69	10
806287^	KO10716A-24	3/4	40	80	10

Item Code	Part No.	107.16(L100) (mm)	L (mm)	R (mm)	(g)	(pcs.)
806288^	KO10716M10(L100)	10	100	13	122	10
806289^	KO10716M12(L100)	12	100	15	146	10
806291^	KO10716M14(L100)	14	100	-	166	10
806293^	KO10716M17(L100)	17	100	-	193	10
806295^	KO10716M19(L100)	19	100	-	232	10
806296^	KO10716M22(L100)	22	100	-	254	10

107-16 (IP)

TORXPLUS® Bits

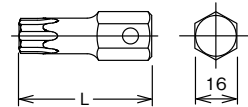

Item Code	Part No.	107.16 (IP)	L (mm)	(g)	(pcs.)
806280^	KO10716-55IP	55IP	50	57	10
806281^	KO10716-60IP	60IP	50	64	10
806282^	KO10716-70IP	70IP	50	73	10

18106

Bit Holder

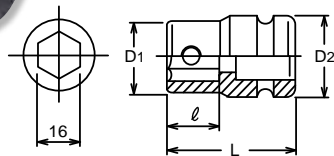

Item Code	Part No.	D ₁ (mm)	D ₂ (mm)	ℓ (mm)	L (mm)	(g)	(pcs.)	
806711^	KO18106	32	54	16	68	640	2	*1

*1 C-Ring=1801C, Pin/O-Ring=1801A/B

Replacement Screw : M6x10, 3mm



1" Impact Sockets & Accessories

18107 Bit Holder



Item Code	Part No.	D1 (mm)	D2 (mm)	l (mm)	L (mm)	(g)	(pcs.)	
504092 [^]	KO18107	44	54	22	70	770	2	*1

*1 C-Ring=1801C, Pin/O-Ring=1801A/B

 Replacement Screw : M8x14,  4mm

18770 Universal Joint



Item Code	Part No.	L (mm)	(g)	(pce.)	
504229	KO18770	127	1350	1	*1

*1 C-Ring=1801C, Pin/O-Ring=1801A/B

107-22 Bits for Inhex Screws



Item Code	Part No.	107.22 (mm)	L (mm)	(g)	(pcs.)
806305 [^]	KO10722M17	17	50	120	10
503640 [^]	KO10722M19	19	50	140	10
503641 [^]	KO10722M22	22	50	162	10
503642 [^]	KO10722M24	24	50	176	10
503643 [^]	KO10722M27	27	50	200	10
806306 [^]	KO10722M30	30	50	227	10
806307 [^]	KO10722M32	32	55	243	10

Item Code	Part No.	107.22 (inch)	L (mm)	(g)	(pcs.)
806300 [^]	KO10722A20	5/8	50	120	10
806301 [^]	KO10722A24	3/4	50	140	10
806302 [^]	KO10722A28	7/8	50	162	10
806303 [^]	KO10722A32	1	50	190	10
806304 [^]	KO10722A40	1. 1/4	55	243	10

107-22 (T) TORX® Bits



Item Code	Part No.	107.22 (T)	L (mm)	(g)	(pcs.)
503645 [^]	KO10722T80	T 80	60	141	10
503646 [^]	KO10722T90	T 90	60	155	10
503644 [^]	KO10722T100	T100	60	170	10

18760 Extension Bars

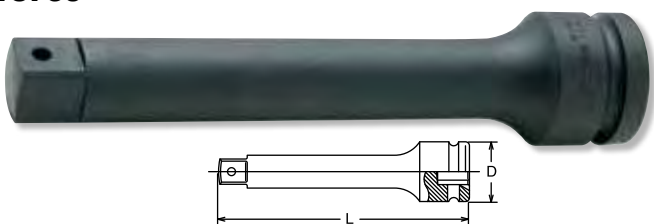

Item Code	Part No.	D (mm)	L (mm)	(g)	(pce.)	
504225 [^]	KO18760175	54	175	1400	1	*1
504226 [^]	KO18760200	54	200	1580	1	*1
504227 [^]	KO18760250	54	250	1885	1	*1
504228 [^]	KO18760330	54	330	2380	1	*1

*1 C-Ring=1801C, Pin/O-Ring=1801A/B

18771 Universal Joint



Item Code	Part No.	L (mm)	(g)	(pce.)	
806750 [^]	KO18771	115	1210	1	*1

*1 C-Ring=1801C, Pin/O-Ring=1801A/B

18866A Reducer



Item Code	Part No.	(sq.)	(sq.)	L (mm)	(g)	(pce.)	
504231	KO18866A	1"	3/4"	67	580	1	*1

*1 C-Ring=1801C, Pin/O-Ring=1801A/B

 Adapting down from bigger square drive to smaller square drive may lead to excessive torque load and possibly cause breakage. Always stay within safe torque of the smaller square drive.

18877A Adaptor



Item Code	Part No.	(sq.)	(sq.)	L (mm)	(g)	(pce.)	
504232 [^]	KO18877A	1"	1.1/2"	80	935	1	*1

*1 C-Ring=1801C, Pin/O-Ring=1801A/B

1" Impact Sockets & Accessories

1801A Spare Pin

1802A

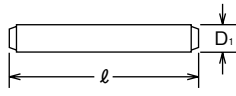

Item Code	Part No.	1"	Opening (mm)	D ₁ (mm)	l (mm)	pcs.
504089	KO1801A	1"	≤ 70	6	45	10
807348	KO1802A	1"	> 70	6	75	10

1801B Spare Ring

1802B



Item Code	Part No.	1"	Opening (mm)	D ₂ (mm)	D ₃ (mm)	pcs.
504090	KO1801B	1"	≤ 70	7	45	10
807349	KO1802B	1"	> 90	10	114	10

1801C-10 C-Ring 10 Clips + Puller

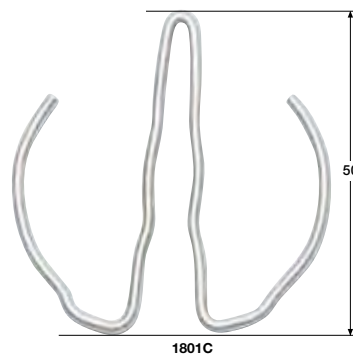

Item Code	Part No.	1"	Opening (mm)	C-Ring 10pcs.	Puller 1pce.
504091	KO1801C-10	1"	≤ 70	1801C + 152	

Z-SERIES

HAND SOCKETS

SCREWDRIVERS

IMPACT

ACCESSORIES

AUTOMOTIVE

RENEWAL KITS

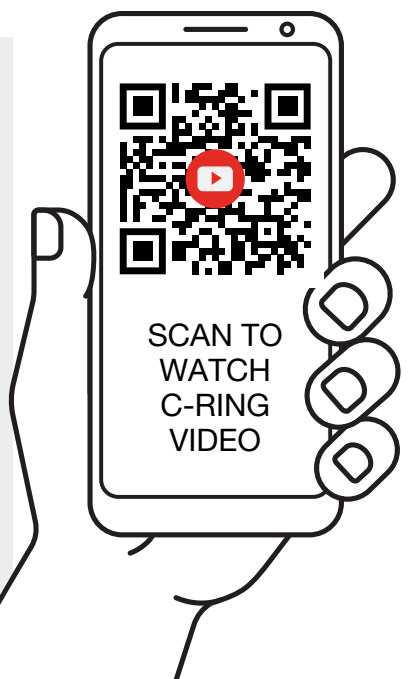
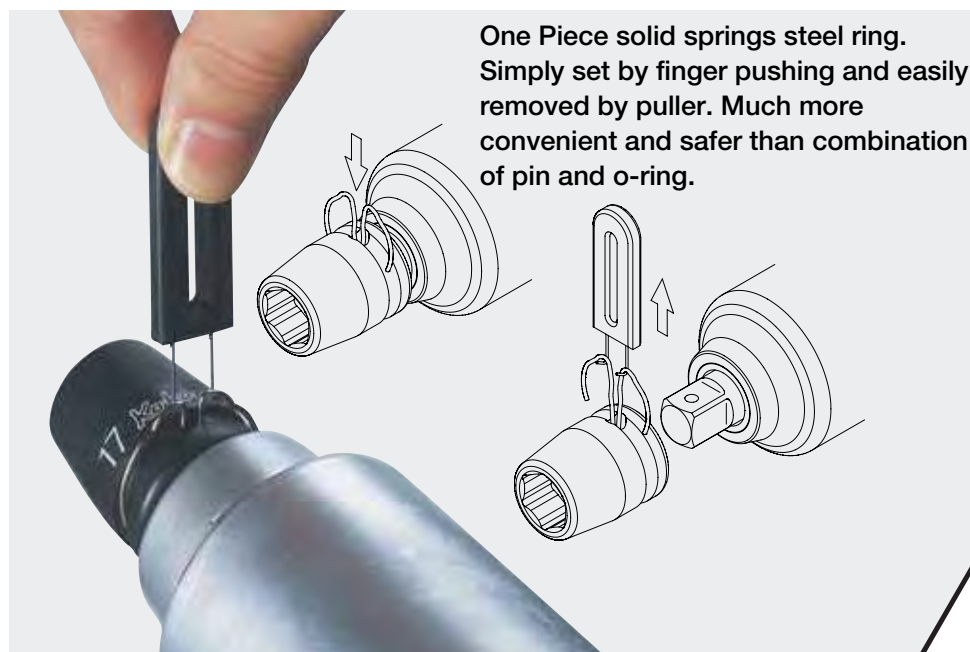

1. 1 1/2" Impact Sockets & Accessories

17400M · 17400A 6-point Sockets

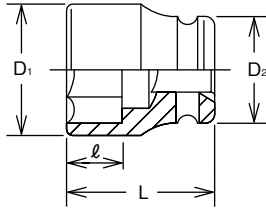

Item Code	Part No.	17400M (mm)	D ₁ (mm)	D ₂ (mm)	l (mm)	L (mm)	(g)	(pce.)	
806672 [^]	KO17400M36	36	62	86	20	77	2126	1	*1
806673 [^]	KO17400M41	41	68	86	22	80	2346	1	*1
806674 [^]	KO17400M42	42	70	86	22	80	2330	1	*1
806675 [^]	KO17400M46	46	74	86	26	84	2360	1	*1
504088 [^]	KO17400M50	50	79	86	27	84	2400	1	*1
806676 [^]	KO17400M52	52	82	86	38	84	2340	1	*1
806677 [^]	KO17400M54	54	84	86	38	84	2340	1	*1
511080 [^]	KO17400M55	55	85	86	44	90	2450	1	*1
505829 [^]	KO17400M58	58	88	86	44	90	2510	1	*1
511081 [^]	KO17400M60	60	91	86	43	90	2640	1	*1
806678 [^]	KO17400M65	65	97	86	48	95	3050	1	*1
505830 [^]	KO17400M70	70	103	86	52	100	3350	1	*1
505831 [^]	KO17400M75	75	108	86	56	105	3700	1	*1
806679 [^]	KO17400M80	80	115	86	60	110	4240	1	*1
807138 [^]	KO17400M85	85	122	86	60	110	4550	1	*1
806680 [^]	KO17400M90	90	128	86	60	112	4840	1	*1
806681 [^]	KO17400M95	95	135	127	52	112	7660	1	*2
806663 [^]	KO17400M100	100	140	127	53	115	7700	1	*2
806664 [^]	KO17400M105	105	146	127	57	120	8000	1	*2
806665 [^]	KO17400M110	110	153	127	60	124	9200	1	*2
807139 [^]	KO17400M115	115	160	127	62	128	10700	1	*2
806666 [^]	KO17400M120	120	166	127	64	132	11200	1	*2
806667 [^]	KO17400M125	125	173	127	67	136	13000	1	*2
806668 [^]	KO17400M130	130	180	127	69	140	14200	1	*2
806669 [^]	KO17400M135	135	186	127	73	145	14940	1	*2
806670 [^]	KO17400M140	140	190	127	76	150	15600	1	*2
806671 [^]	KO17400M150	150	200	127	83	160	16500	1	*2

*1 Pin/O-Ring=1701A/B
*2 Pin/O-Ring=1702A/B

Item Code	Part No.	17400A (inch)	D ₁ (mm)	D ₂ (mm)	l (mm)	L (mm)	(g)	(pce.)	
505812 [^]	KO17400A52	1. 5/8	68	86	22	80	2346	1	*1
505813 [^]	KO17400A54	1.11/16	71	86	22	80	2300	1	*1
505814 [^]	KO17400A56	1. 3/4	73	86	22	80	2290	1	*1
505815 [^]	KO17400A58	1.13/16	74	86	26	84	2360	1	*1
504084 [^]	KO17400A60	1. 7/8	77	86	26	84	2440	1	*1
504085 [^]	KO17400A62	1.15/16	79	86	27	84	2400	1	*1
505817 [^]	KO17400A64	2	80	86	27	84	2420	1	*1
505818 [^]	KO17400A66	2. 1/16	82	86	38	84	2340	1	*1
505819 [^]	KO17400A68	2. 1/8	84	86	38	84	2340	1	*1
504086 [^]	KO17400A70	2. 3/16	85	86	44	90	2450	1	*1
505821 [^]	KO17400A72	2. 1/4	87	86	43	90	2460	1	*1
505822 [^]	KO17400A74	2. 5/16	88	86	44	90	2510	1	*1
505823 [^]	KO17400A76	2. 3/8	91	86	43	90	2640	1	*1
505824 [^]	KO17400A78	2. 7/16	93	86	47	95	2860	1	*1
505825 [^]	KO17400A80	2. 1/2	96	86	47	95	3000	1	*1
504087 [^]	KO17400A82	2. 9/16	97	86	48	95	3050	1	*1
505826 [^]	KO17400A84	2. 5/8	100	86	51	100	3300	1	*1
806662 [^]	KO17400A86	2.11/16	101	86	51	100	3300	1	*1
505827 [^]	KO17400A88	2. 3/4	103	86	52	100	3350	1	*1
505828 [^]	KO17400A92	2. 7/8	106	86	55	105	3610	1	*1

*1 Pin/O-Ring=1701A/B

17760-175 · -250 · -330 Extension Bars

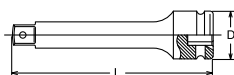

Item Code	Part No.	D (mm)	L (mm)	(g)	(pce.)	
806682 [^]	KO17760175	86	175	3300	1	*1
806683 [^]	KO17760250	86	250	4500	1	*1
806684 [^]	KO17760300	86	330	5200	1	*1

*1 C-Ring=1700C, Pin/O-Ring=1701A/B

17770 Universal Joint

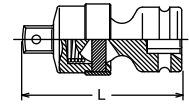

Item Code	Part No.	L (mm)	(g)	(pce.)	
806685 [^]	KO17770	200	4700	1	*1

*Pin/O-Ring=1701A/B

17788A Adaptor

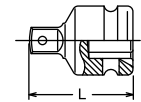

NO WARRANTY

Item Code	Part No.	(sq.)	(sq.)	L (mm)	(g)	(pce.)	
806686 [^]	KO17788A	1.1/2"	1"	98	2600	1	*1

*O-Ring=1701A/B

 Adapting down from bigger square drive to smaller square drive may lead to excessive torque load and possibly cause breakage. Always stay within safe torque of the smaller square drive.

17799A Adaptor

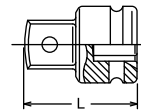

Item Code	Part No.	(sq.)	(sq.)	L (mm)	(g)	(pce.)	
806687 [^]	KO17799A	1.1/2"	2.1/2"	115	3790	1	*1

*1 Pin/O-Ring=1701A/B

1701A Spare Pin

1702A

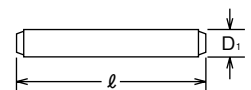
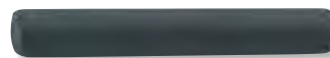

Item Code	Part No.	Opening (mm)	D ₁ (mm)	l (mm)	(pcs.)
807350	KO1701A	1-1/2"	≤ 90	75	10
807351	KO1702A	1-1/2"	> 90	110	10

1701B Spare Ring

1702B



Item Code	Part No.	Opening (mm)	D ₂ (mm)	D ₃ (mm)	(pcs.)
807352	KO1701B	1-1/2"	≤ 90	75	10
807353	KO1702B	1-1/2"	> 90	114	10

Accessories



Accessories



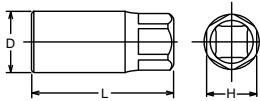

4100M · 4100A Screw and Stud Pullers



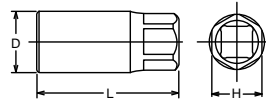



Screw and Stud Pullers
Hexagon body design can lessen the excessive load on cages and rollers inside the pullers.

6100M Screw and Stud Pullers



Item Code	Part No.	4100M (mm)		D (mm)	L (mm)	H (mm)	 (g)	 (pcs.)
504879	KO4100M06	6		24	65	21	150	10
504880^	KO4100M07	7		24	65	21	150	10
504881	KO4100M08	8		24	65	21	147	10
504882^	KO4100M09	9		28	75	21	217	10
504883	KO4100M10	10		28	75	21	213	10
504884^	KO4100M10.5	10.5		28	75	21	202	10
504885^	KO4100M11	11		28	75	21	218	10
504886	KO4100M12	12		28	75	21	220	10
504887^	KO4100M14	14		34	75	27	340	5
504888	KO4100M16	16		34	75	27	315	5

Item Code	Part No.	4100A (inch)		D (mm)	L (mm)	H (mm)	 (g)	 (pcs.)
504861	KO4100A08	1/4		24	65	21	150	10
504862	KO4100A10	5/16		24	65	21	147	10
504863	KO4100A12	3/8		28	75	21	213	10
504864	KO4100A14	7/16		28	75	21	218	10
504865	KO4100A16	1/2		28	75	21	191	10
504866	KO4100A18	9/16		34	75	27	340	5
504867	KO4100A20	5/8		34	75	27	315	5

* Renewal Kits -- 4100RK

 4100M-16 and 4100A-5/8 do not have 1/2" square drive. Drive the outer hexagon part with 27mm sockets or ring wrenches.





Tolerances





4100M (mm)	4100A (inch)
6	5.6 - 6
7	6.6 - 7
8	7.6 - 8
9	8.4 - 9
10	9.4 - 10
10.5	9.9 - 10.5
11	10.4 - 11
12	11.4 - 12
14	13.2 - 14
16	15.2 - 16

4211M · 4211A Screw and Stud Pullers Sets



METAL CASE:W215xH80xT47mm

Item Code	Part No.		Puller Sets	 (g)
504923	KO4211M		4100M Stud Pullers: 4 Piece Set 6, 8, 10, 12	1,040
504922	KO4211A		4100A Stud Pullers: 4 Piece Set 1/4, 5/16, 3/8, 1/2"	1,040

Item Code	Part No.	6100M (mm)		D (mm)	L (mm)	H (mm)	 (g)	 (pce.)
806996^	KO6100M18	18		48	100	36	840	1
505272^	KO6100M20	20		48	100	36	816	1
806997^	KO6100M22	22		48	100	36	745	1
505273^	KO6100M24	24		48	100	36	739	1
806998^	KO6100M27	27		63	125	46	1707	1
806999^	KO6100M28	28		63	125	46	1701	1
807000^	KO6100M29	29		63	125	46	1696	1
505274^	KO6100M30	30		63	125	46	1691	1

* Renewal Kits -- 6100MRK

 6100M-22 to -30 do not have 3/4" square drive. Drive the outer hexagon part with sockets or ring wrenches (size 22-24mm = 36H, 27-30mm = 46H).

Tolerances





6100M (mm)	
18	16.9 - 18
20	18.8 - 20
22	20.8 - 22
24	22.7 - 24
27	25.7 - 27
28	26.7 - 28
29	27.6 - 29
30	28.6 - 30

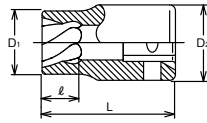

Accessories





2127 NUTTWISER®

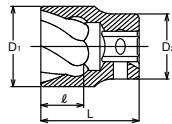

Item Code	Part No.	2127 (mm)		D ₁ (mm)	D ₂ (mm)	ℓ (mm)	L (mm)	 (g)	 (pcs.)
806759 [^]	KO2127-4	4		7	13	4	23	14	10
806760 [^]	KO2127-5	5		8	13	5	23	14	10
806761 [^]	KO2127-6	6		9.5	13	6	23	14	10
806762 [^]	KO2127-7	7		10.9	13	6	23	14	10
806763 [^]	KO2127-8	8		11.5	13	8	23	14	10
806764 [^]	KO2127-9	9		13	13	8	23	15	10
806758 [^]	KO2127-10	10		14.8	13	10	23	17	10





3127 NUTTWISER®

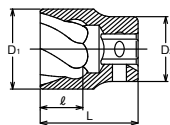

Item Code	Part No.	3127 (mm)		D ₁ (mm)	D ₂ (mm)	ℓ (mm)	L (mm)	 (g)	 (pcs.)
504523 [^]	KO3127M08	8		11.5	19	8	32	40	10
504524 [^]	KO3127M09	9		13	19	8	32	40	10
504525 [^]	KO3127M10	10		14.8	19	10	32	41	10
504526 [^]	KO3127M11	11		16	19	10	32	43	10
504527 [^]	KO3127M12	12		17	19	12	32	44	10
504528 [^]	KO3127M13	13		18.5	19	12	32	46	10
504529 [^]	KO3127M14	14		19.7	19	14	32	48	10
504530 [^]	KO3127M15	15		20.7	19	14	32	52	10
504531 [^]	KO3127M16	16		22.2	22	14	32	66	10
504532 [^]	KO3127M17	17		23.5	22	16	35	80	10

4127 NUTTWISER®







Item Code	Part No.	4127 (mm)		D ₁ (mm)	D ₂ (mm)	ℓ (mm)	L (mm)	 (g)	 (pcs.)
504909 [^]	KO4127M14	14		19.7	30	14	42	125	10
504910 [^]	KO4127M17	17		23.5	30	16	42	137	10
504911 [^]	KO4127M19	19		26	30	16	42	146	10
504912 [^]	KO4127M21	21		28	30	17	42	153	10
504913 [^]	KO4127M22	22		29.5	30	17	42	158	10
504914 [^]	KO4127M24	24		32	30	18	42	174	10
504915 [^]	KO4127M25.4	25.4		33.5	30	18	42	183	10

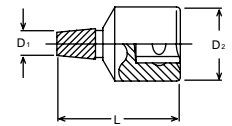

 A very effective method and easy solution for removing rounded off nuts, bolts and studs. The sharp edges of the NUTTWISER® Socket opening will tighten around the nut, bolt or stud and turn it easily off.

3129-32 BOLTWISER®



Item Code	Part No.	3129.32 (mm)		D ₁ (mm)	D ₂ (mm)	L (mm)	 (g)	 (pcs.)
806853 [^]	KO3129-32-2	2		2	19	32	32	10
806854 [^]	KO3129-32-3	3		3	19	32	33	10
806855 [^]	KO3129-32-4	4		4	19	32	33	10
806856 [^]	KO3129-32-6	6		6	19	32	35	10
806857 [^]	KO3129-32-8	8		8	19	32	37	10
806852 [^]	KO3129-32-10	10		10	19	32	40	10





RS3129/6-L32 BOLTWISER® Socket Set on Rail

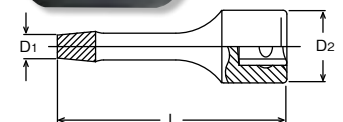

Item Code	Part No.	Socket Sets	 (g)
505569 [^]	KORS3129/6-L32	3129-32: 6 Piece Set / Rail 150mm 2, 3, 4, 6, 8, 10	250

3129-60 BOLTWISER®



Item Code	Part No.	3129.60 (mm)		D ₁ (mm)	D ₂ (mm)	L (mm)	 (g)	 (pcs.)
806859 [^]	KO3129-60-2	2		2	19	60	38	10
806860 [^]	KO3129-60-3	3		3	19	60	42	10
806861 [^]	KO3129-60-4	4		4	19	60	44	10
806862 [^]	KO3129-60-6	6		6	19	60	47	10
806863 [^]	KO3129-60-8	8		8	19	60	53	10
806858 [^]	KO3129-60-10	10		10	19	60	64	10

RS3129/6-L60 BOLTWISER® Socket Set on Rail



Item Code	Part No.	Socket Sets	 (g)
505570 [^]	KORS3129/6-L60	3129-60: 6 Piece Set / Rail 150mm 2, 3, 4, 6, 8, 10	320

Accessories

4129-37 BOLT TWISTER®



Item Code	Part No.	4129.37 (mm)	□	D ₁ (mm)	D ₂ (mm)	L (mm)	(g)	(pcs.)
806938 [^]	KO4129-37-08	8	1/2"	8	24	37	59	10
806934 [^]	KO4129-37-10	10		10	24	37	63	10
806935 [^]	KO4129-37-12	12		12	24	37	67	10
806936 [^]	KO4129-37-14	14		14	24	37	72	10
806937 [^]	KO4129-37-16	16		16	24	37	78	10

RS4129/5-L37 Socket Set on Rail



Item Code	Part No.	BOLT TWISTER Socket Sets	(g)
505601 [^]	KORS4129/5-L37	4129.37: 5 Piece Set/Rail 150mm 8, 10, 12, 14, 16	370

4129-75 BOLT TWISTER®



Item Code	Part No.	4129.75 (mm)	□	D ₁ (mm)	D ₂ (mm)	L (mm)	(g)	(pcs.)
806943 [^]	KO4129-75-08	8	1/2"	8	24	75	80	10
806939 [^]	KO4129-75-10	10		10	24	75	94	10
806940 [^]	KO4129-75-12	12		12	24	75	110	10
806941 [^]	KO4129-75-14	14		14	24	75	130	10
806942 [^]	KO4129-75-16	16		16	24	75	150	10

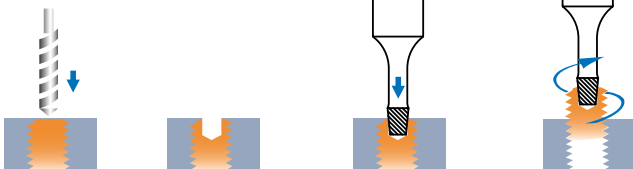

BOLT TWISTER	Bolt size	Drill size
2	M5	φ 2.4 - 2.6
3	M6	φ 3.2 - 3.5
4	M8	φ 4.2 - 4.5
6	M10 - M12	φ 6.2 - 6.5
8	M14 - M16	φ 8.2 - 8.5
10	M18 - M20	φ10.2 - 10.5
12	M22 - M24	φ12.2 - 12.5
14	M27 - M30	φ14.2 - 14.5
16	M33	φ16.2 - 16.5

Effective method and easy solution for removing twisted off bolt.

Drill a hole in the center of bolt and drive BOLT TWISTER® firmly into the hole.

The sharp spiral edges will hold the broken bolt and easily remove it.

RS4129/5-L75 Socket Set on Rail



Item Code	Part No.	BOLT TWISTER Socket Sets	(g)
505602 [^]	KORS4129/5-L75	4129.75: 5 Piece Set/Rail 150mm 8, 10, 12, 14, 16	600

156M 6-point Deep

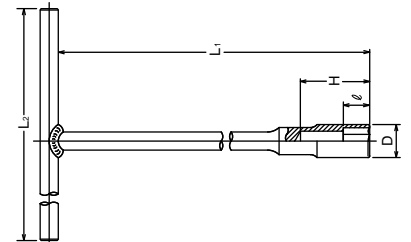

Item Code	Part No.	156M (mm)	D (mm)	ℓ (mm)	H (mm)	L1 (mm)	L2 (mm)	(g)	(pcs.)
900019 [^]	KO156M08	8	12	9	41	355	200	231	1
900020 [^]	KO156M10	10	14.5	11	41	355	200	289	1
900021 [^]	KO156M12	12	16.8	13	41	355	200	429	1
900022 [^]	KO156M14	14	20	16	41	355	200	454	1

Z-SERIES

HAND SOCKETS

SCREWDRIVERS

IMPACT

ACCESSORIES



AUTOMOTIVE



RENEWAL KITS

Accessories

104M · 104A 6-Point T-Handle Wrench





Item Code	Part No.	104M (mm)	D (mm)	ℓ (mm)	L1 (mm)	L2 (mm)	 (g)	 (pce.)
503610	KO104M06	6	9.5	8	200	180	150	1
503611	KO104M07	7	11	9	200	180	152	1
503612	KO104M08	8	12	10	250	200	183	1
503613	KO104M09	9	14	12	250	200	188	1
503614	KO104M10	10	14	13	250	200	230	1
503615	KO104M11	11	16	14	250	200	234	1
503616	KO104M12	12	18	15	250	250	384	1
503617	KO104M13	13	18.5	17	300	250	412	1
503618	KO104M14	14	20	18	300	250	428	1
503619	KO104M15	15	21	19	300	250	443	1
807156	KO104M16	16	22.5	21	350	300	528	1
503620	KO104M17	17	24	22	350	300	707	1
503621	KO104M18	18	25	23	350	300	707	1
503622	KO104M19	19	26.5	25	350	300	717	1
503623	KO104M21	21	29	27	350	300	1070	1
503624	KO104M22	22	30	28	350	300	1062	1
807157	KO104M24	24	33	30	350	300	1140	1

Item Code	Part No.	104A (inch)	D (mm)	ℓ (mm)	L1 (mm)	L2 (mm)	 (g)	 (pce.)
503603^	KO104A12	3/8	14	12	250	200	188	1
503604^	KO104A14	7/16	16	14	250	200	234	1
503605^	KO104A16	1/2	18.5	17	300	250	412	1
503606^	KO104A18	9/16	20	18	300	250	428	1
503607^	KO104A20	5/8	22.5	21	350	300	528	1
503609^	KO104A24	3/4	26.5	25	350	300	717	1

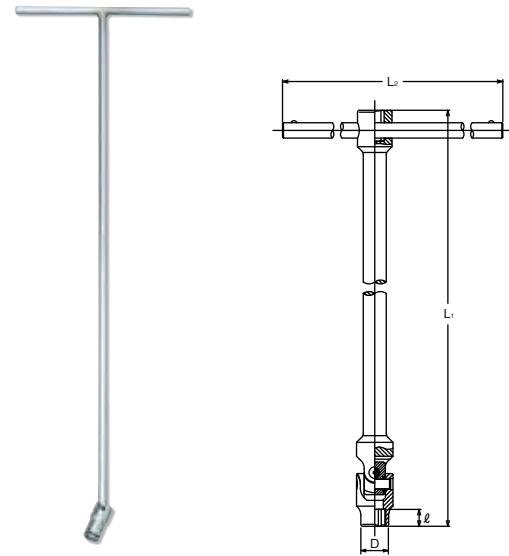
124M-600 (2B) Ball Joint plus Nut Grip Socket







Item Code	Part No.	124M.600 (mm)	D (mm)	ℓ (mm)	L1 (mm)	L2 (mm)	 (g)	 (pce.)
505631^	KO124M08	8(2B)	12	5	600	200	332	1
505632^	KO124M10	10(2B)	14.5	6	600	200	334	1
505633^	KO124M12	12(2B)	16.8	7	600	200	424	1
505634^	KO124M13	13(2B)	18	8	600	200	425	1
505635^	KO124M14	14(2B)	19.5	8.5	600	200	527	1
505636^	KO124M17	17(2B)	23.3	9.5	600	200	538	1

NUT GRIP®

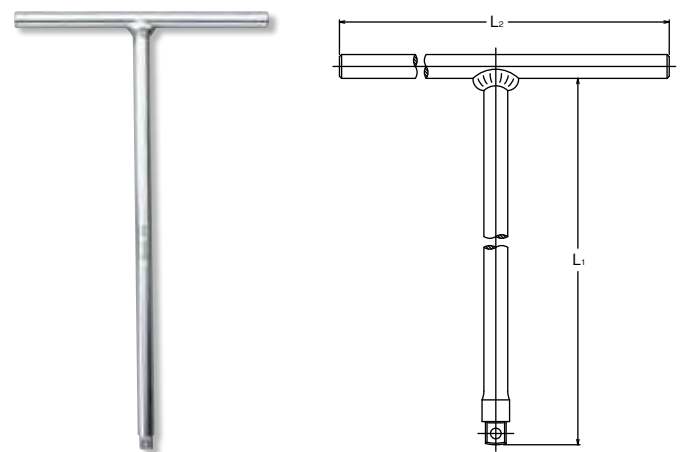
Twin balls at the 6-point opening hold the bolt/nut tightly for safe and reliable work.

2715 T-Handle



Item Code	Part No.		L1 (mm)	L2 (mm)	 (g)	 (pce.)
504393	KO2715	1/4"	200	120	130	1

Accessories

Z-SERIES

HAND SOCKETS

SCREWDRIVERS

IMPACT

ACCESSORIES

AUTOMOTIVE

RENEWAL KITS

3715  T-Handle



3715S  T-Handle



3715SL  T-Handle



3716  T-Handle 



3715SLK  T-Handle

T-Handle

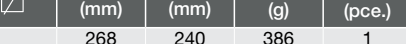
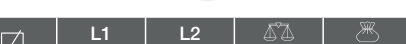

4715  T-Handle







4715S  T-Handle

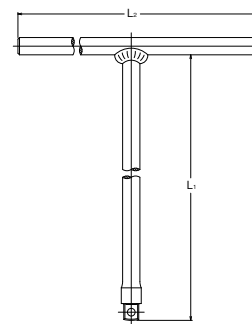
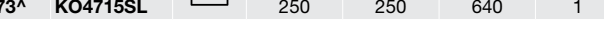
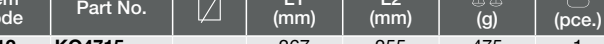

4715SL  T-Handle



Item Code	Part No.		L1 (mm)	L2 (mm)	 (g)	 (pce.)
504745	KO3715		268	240	386	1
804507^	KO3715S		268	190	347	1
504746^	KO3715SL		237	200	325	1
504747	KO3716		268	240	379	1
505890	KO3715SLK		236	200	470	1

 3715/3716 This tool is used sockets in hard to reach places. 3716 has a reduced square drive and similar function as offset extension bars.







Photo: 3715SLK

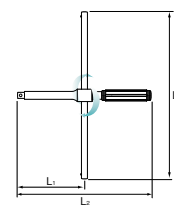

4711X  Spinning Cross Wrench



Item Code	Part No.		L1 (mm)	L2 (mm)	L3 (mm)	 (g)	 (pce.)
511121^	KO4711X		140	280	350	945	1

Accessories

3131A Tap Holder, Adjustable



Item Code	Part No.	3131A	□	S(mm)		L (mm)	⚖️ (g)	📦 (pcs.)
				Min.	Max.			
806864	KO3131A1	1	□ ^{3/8"}	2.0	5.0	42	80	5
806865	KO3131A2	2	□ ^{3/8"}	4.5	8.0	47	100	5

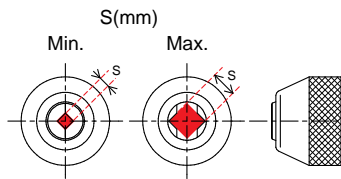

160K Handle Llave



Item Code	Part No.	□	C (mm)	L (mm)	⚖️ (g)	📦 (pcs.)
807158	KO160K	□ ^{3/8"}	10	220	130	1
807159	KO160K-1/2	□ ^{1/2"}	10	220	135	1

102NM · 102NA Ratcheting Ring Wrench Without Reverse Lever

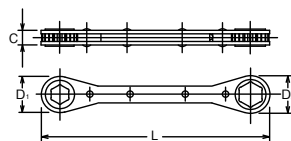

Item Code	Part No.	102NM (mm)	L (mm)	D ₁ (mm)	D ₂ (mm)	C (mm)	⚖️ (g)	📦 (pcs.)
806258 [^]	KO102NM-6x7	6x 7	108	15.3	16.4	7.5	60	10
806259 [^]	KO102NM-7x8	7x 8	108	15.3	16.4	7.5	60	10
806261 [^]	KO102NM-8x9	8x 9	134	17.1	19.7	7.5	80	10
806260 [^]	KO102NM-8x10	8x10	134	17.1	19.7	7.5	80	10
806254 [^]	KO102NM-10x11	10x11	140	20.1	22.7	7.5	87	10
807161	KO102NM-10x12	10x12	140	20.1	22.7	7.5	87	10
806255 [^]	KO102NM-11x13	11x13	145	23.6	24.6	9	112	10
806256 [^]	KO102NM-12x13	12x13	145	23.6	24.6	9	112	10
806257 [^]	KO102NM-12x14	12x14	145	23.6	24.6	9	112	10

Item Code	Part No.	102NA (inch)	L (mm)	D ₁ (mm)	D ₂ (mm)	C (mm)	⚖️ (g)	📦 (pcs.)
806253 [^]	KO102NA-7/32x1/4	7/32x1/4	108	15.3	16.4	7.5	60	10
806249 [^]	KO102NA-1/4x9/32	1/4x9/32	108	15.3	16.4	7.5	60	10
505624 [^]	KO102NA-1/4x5/16	1/4x5/16	108	15.3	16.4	7.5	60	10
806250 [^]	KO102NA-5/16x11/32	5/16x11/32	134	17.1	19.7	7.5	80	10
806251 [^]	KO102NA-5/16x3/8	5/16x3/8	134	17.1	19.7	7.5	80	10
505625 [^]	KO102NA-3/8x7/16	3/8x7/16	140	20.1	22.7	7.5	87	10
806252 [^]	KO102NA-7/16x1/2	7/16x1/2	145	23.6	24.6	9	112	10
806248 [^]	KO102NA-1/2x9/16	1/2x9/16	145	23.6	24.6	9	112	5

Disclaimer: Every effort has been made to publish the correct details in this brochure. No responsibility will be taken for errors, omissions or changes in product specifications. [^] Special Order Only

103KM · 103KA Reversible Ratcheting Ring Wrench

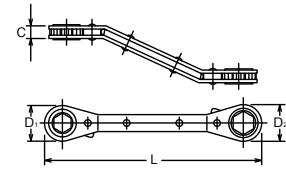

Item Code	Part No.	103KM (mm)	L (mm)	D ₁ (mm)	D ₂ (mm)	C (mm)	⚖️ (g)	📦 (pcs.)
806272 [^]	KO103KM-6x7	6x 7	108	15.3	16.4	7.5	51	5
806273 [^]	KO103KM-7x8	7x 8	108	15.3	16.4	7.5	51	5
806275 [^]	KO103KM-8x9	8x 9	134	17	20	9	76	5
806274 [^]	KO103KM-8x10	8x10	134	17	20	9	76	5
806268 [^]	KO103KM-10x11	10x11	140	21	23.5	9	84	5
806269 [^]	KO103KM-10x12	10x12	140	21	23.5	9	84	5
806270 [^]	KO103KM-12x13	12x13	145	24	25	9	89	5
806271 [^]	KO103KM-12x14	12x14	145	24	25	9	89	5

Item Code	Part No.	103KA (inch)	L (mm)	D ₁ (mm)	D ₂ (mm)	C (mm)	⚖️ (g)	📦 (pcs.)
806267 [^]	KO103KA-7/32x1/4	7/32x 1/4	108	15.3	16.4	7.5	51	5
806263 [^]	KO103KA-1/4x5/16	1/4 x 5/16	108	15.3	16.4	7.5	51	5
806265 [^]	KO103KA-5/16x11/32	5/16x 11/32	134	17	20	9	76	5
806266 [^]	KO103KA-5/16x3/8	5/16x 3/8	134	17	20	9	76	5
806264 [^]	KO103KA-3/8x7/16	3/8 x 7/16	140	21	23.5	9	84	5
807160	KO103KA-7/16x1/2	7/16x 1/2	145	24	25	9	89	5
806262 [^]	KO103KA-1/2x9/16	1/2 x 9/16	145	24	25	9	89	5

Z-SERIES

HAND SOCKETS

SCREWDRIVERS

IMPACT

ACCESSORIES

AUTOMOTIVE

RENEWAL KITS

Attack Driver®

Z-SERIES

3112N Attack Driver



HAND SOCKETS

3112G Attack Driver



SCREWDRIVERS

Item Code	Part No.	□	L (mm)	(g)	(pce.)
806851^	KO3112N	3/8"	159	730	1
806850^	KO3112G		159	810	1

* Renewal Kits → 3112RK

IMPACT

4112N Attack Driver



ACCESSORIES

4112G Attack Driver



Item Code	Part No.	□	L (mm)	(g)	(pce.)
806933^	KO4112N	1/2"	163	730	1
504908^	KO4112G		163	810	1

* Renewal Kits → 4112RK

AUTOMOTIVE



Black finished top helps prevent chrome peeling off the head when it is struck

RENEWAL KITS

6112 Attack Driver



Item Code	Part No.	□	L (mm)	(g)	(pce.)
807001^	KO6112	3/4"	190	1900	1

* Renewal Kits → 6112RK

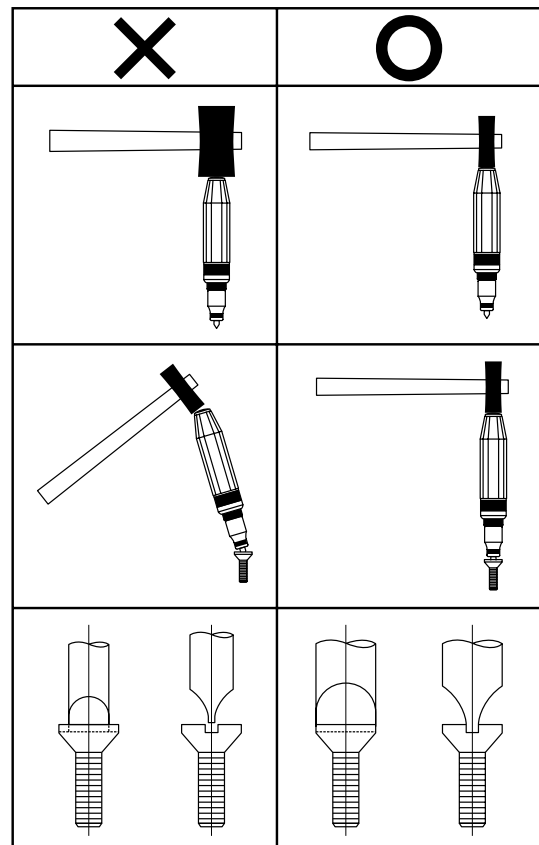



Attack Driver®

AN112A Attack (Impact) Driver Set





6 PIECE SET
METAL CASE: W190×H59×T45mm

Item Code	Part No.	Bits	Accessories	⚖️(g)
505519	KOAN112A	⊕ 100P.32 Phillips Bits 2, 3	 4112N  4138	1,070
		⊖ 100S.32 Slotted Bits 9, 11		

AG112A Attack (Impact) Driver Set



6 PIECE SET
METAL CASE: W220×H82×T60mm



Item Code	Part No.	Bits	Accessories	⚖️(g)
505518	KOAG112A	⊕ 100P.32 Phillips Bits 2, 3	 4112G  4138	1,150
		⊖ 100S.32 Slotted Bits 9, 11		

AN112C Attack (Impact) Driver Set



8 PIECE SET
METAL CASE: W215×H80×T47mm

⚖️ = 1,350g



Item Code	Part No.	Bits	Accessories
505520 [^]	KOAN112C	⊕ 100P.80 Phillips Bits 1, 2, 3	 4112N  4138
		⊖ 100S.80 Slotted Bits 7, 9, 12	

AG112H Attack Driver Set



18 PIECE SET
METAL CASE: W220×H82×T60mm

⚖️ = 1,480g

Item Code	Part No.	Bits	Accessories
505945 [^]	KOAG112H	⊕ 100P.32 Phillips Bits 2, 3, 4	 4112G  4138
		⊖ 100S.32 Slotted Bits 8, 9, 10, 12, 14	
		⊕ 100H.32 Hex Bits 5, 6, 8, 10	
		⊕ 100T.32 TORX® Bits T30, T40, T45, T50	

TORX is a registered trademark of Acument Intellectual Properties, LLC.
TORX es una marca registrada de Acument Intellectual Properties, LLC.

1/4" Bits & Holders

108P-25 ⊕ Phillips Bits

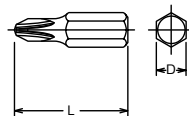

Item Code	Part No.	108P.25 (PH)	D (mm)	L (mm)	⚖️(g)	📦(pcs.)
807106 [^]	KO108P25/1	1	6.35	25	5	10
807107 [^]	KO108P25/2	2	6.35	25	5	10
807108 [^]	KO108P25/3	3	6.35	25	6	10

108S-25 ⊖ Bits for Slotted head

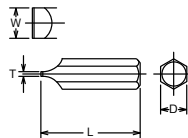

Item Code	Part No.	108S.25 (mm)	T×W (mm)	D (mm)	L (mm)	⚖️(g)	📦(pcs.)
807109 [^]	KO108S25/3	3	0.5×3	6.35	25	3	10
807110 [^]	KO108S25/4	4	0.6×4	6.35	25	3	10
807111 [^]	KO108S25/4.5	4.5	0.6×4.5	6.35	25	4	10
807112 [^]	KO108S25/5	5	0.8×5	6.35	25	5	10
807113 [^]	KO108S25/5.5	5.5	0.8×5.5	6.35	25	5	10
807114 [^]	KO108S25/6	6	1.0×6	6.35	25	5	10
807115 [^]	KO108S25/8	8	1.2×8	6.35	25	6	10

108H-25 ⊕ Hex Bits

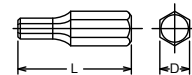

Item Code	Part No.	108H.25 (mm)	D (mm)	L (mm)	⚖️(g)	📦(pcs.)
807116 [^]	KO108H25/3	3	6.35	25	4	10
807117 [^]	KO108H25/4	4	6.35	25	5	10
807118 [^]	KO108H25/5	5	6.35	25	5	10
807119 [^]	KO108H25/6	6	6.35	25	6	10
807120 [^]	KO108H25/7	7	6.35	25	7	10
807121 [^]	KO108H25/8	8	6.35	25	8	10
807354 [^]	KO108H25/10	10	6.35	25	11	10

108T-25 (T) ⊕ TORX® Bits

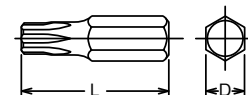

Item Code	Part No.	108T.25 (T)	D (mm)	L (mm)	⚖️(g)	📦(pcs.)
807122 [^]	KO108T25T08	T 8	6.35	25	4	10
807123 [^]	KO108T25T10	T10	6.35	25	4	10
807124 [^]	KO108T25T15	T15	6.35	25	4	10
807125 [^]	KO108T25T20	T20	6.35	25	5	10
807126 [^]	KO108T25T25	T25	6.35	25	6	10
807127 [^]	KO108T25T27	T27	6.35	25	6	10
807128 [^]	KO108T25T30	T30	6.35	25	6	10
807129 [^]	KO108T25T40	T40	6.35	25	6	10

Disclaimer: Every effort has been made to publish the correct details in this brochure. No responsibility will be taken for errors, omissions or changes in product specifications. [^] Special Order Only

1/4" Bits & Holders

2137  Bit Holder







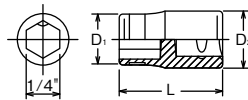
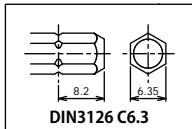

3137  Bit Holder





4137  Bit Holder





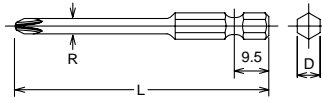

Item Code	Part No.		D ₁ (mm)	D ₂ (mm)	L (mm)	 (g)	 (pcs.)
504247	KO2137		12	12	22.5	13	10
504533	KO3137		13	16.5	30	30	10
505908	KO4137		13	22	38	53	10

121P-70 · -100 · -150  Phillips Bits





Item Code	Part No.	121P.70 (PH)	D (mm)	R (mm)	L (mm)	 (g)	 (pcs.)
806325 [^]	KO121P70/1	1	6.35	4.5	70	15	10
806326 [^]	KO121P70/2	2	6.35	5.5	70	15	10
806327 [^]	KO121P70/3	3	6.35	-	70	16	10

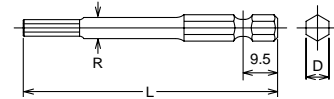

Item Code	Part No.	121P.100 (PH)	D (mm)	R (mm)	L (mm)	 (g)	 (pcs.)
806319 [^]	KO121P100/1	1	6.35	4.5	100	23	10
806320 [^]	KO121P100/2	2	6.35	5.5	100	23	10
806321 [^]	KO121P100/3	3	6.35	-	100	24	10

Item Code	Part No.	121P.150 (PH)	D (mm)	R (mm)	L (mm)	 (g)	 (pcs.)
806322 [^]	KO121P150/1	1	6.35	4.5	150	30	10
806323 [^]	KO121P150/2	2	6.35	5.5	150	35	10
806324 [^]	KO121P150/3	3	6.35	-	150	36	10

121H-70 · -100  Hex Bits







Item Code	Part No.	121H.70 (mm)	D (mm)	R (mm)	L (mm)	 (g)	 (pcs.)
806314 [^]	KO121H70/2	2	6.35	3	70	13	10
806315 [^]	KO121H70/3	3	6.35	3.5	70	15	10
806316 [^]	KO121H70/4	4	6.35	4.5	70	15	10
806317 [^]	KO121H70/5	5	6.35	5.6	70	16	10
806318 [^]	KO121H70/6	6	6.35	-	70	18	10

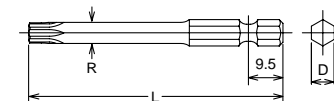

Item Code	Part No.	121H.100 (mm)	D (mm)	R (mm)	L (mm)	 (g)	 (pcs.)
806309 [^]	KO121H100/2	2	6.35	3	100	22	10
806310 [^]	KO121H100/3	3	6.35	3.5	100	23	10
806311 [^]	KO121H100/4	4	6.35	4.5	100	23	10
806312 [^]	KO121H100/5	5	6.35	5.6	100	24	10
806313 [^]	KO121H100/6	6	6.35	-	100	26	10

121T-70 · -100 · -150 (T)  TORX® Bits



Item Code	Part No.	121T.70 (T)	D (mm)	R (mm)	L (mm)	 (g)	 (pcs.)
806342 [^]	KO121T70/T10	T10	6.35	3.5	70	16	10
806343 [^]	KO121T70/T15	T15	6.35	3.5	70	16	10
806344 [^]	KO121T70/T20	T20	6.35	4.1	70	16	10
806345 [^]	KO121T70/T25	T25	6.35	4.6	70	16	10
806346 [^]	KO121T70/T27	T27	6.35	5.2	70	17	10
806347 [^]	KO121T70/T30	T30	6.35	5.7	70	17	10
806348 [^]	KO121T70/T40	T40	6.35	-	70	18	10

Item Code	Part No.	121T.100 (T)	D (mm)	R (mm)	L (mm)	 (g)	 (pcs.)
806328 [^]	KO121T100/T10	T10	6.35	3.5	100	24	10
806329 [^]	KO121T100/T15	T15	6.35	3.5	100	24	10
806330 [^]	KO121T100/T20	T20	6.35	4.1	100	24	10
806331 [^]	KO121T100/T25	T25	6.35	4.6	100	24	10
806332 [^]	KO121T100/T27	T27	6.35	5.2	100	24	10
806333 [^]	KO121T100/T30	T30	6.35	5.7	100	25	10
806334 [^]	KO121T100/T40	T40	6.35	-	100	26	10

Item Code	Part No.	121T.150 (T)	D (mm)	R (mm)	L (mm)	 (g)	 (pcs.)
806335 [^]	KO121T150/T10	T10	6.35	3.5	150	35	10
806336 [^]	KO121T150/T15	T15	6.35	3.5	150	37	10
806337 [^]	KO121T150/T20	T20	6.35	4.1	150	37	10
806338 [^]	KO121T150/T25	T25	6.35	4.6	150	37	10
806339 [^]	KO121T150/T27	T27	6.35	5.2	150	37	10
806340 [^]	KO121T150/T30	T30	6.35	5.7	150	38	10
806341 [^]	KO121T150/T40	T40	6.35	-	150	39	10

Z-SERIES

HAND SOCKETS

SCREWDRIVERS

IMPACT

ACCESSORIES

AUTOMOTIVE

RENEWAL KITS

5/16" Bits & Holders

2138 ○ Bit Holder



3138 ○ Bit Holder



4138 ○ Bit Holder

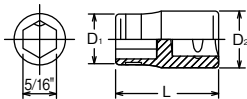
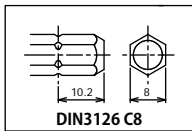

Item Code	Part No.		D ₁ (mm)	D ₂ (mm)	L (mm)	(g)	(pcs.)
806765	KO2138	1/4"	16	16	26	32	10
504534	KO3138	3/8"	16	18	38	55	10
504918	KO4138	1/2"	16	22	38	62	10

100P-32 · -80 ⊕ Phillips Bits

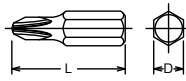

Item Code	Part No.	100P.32 (PH)	D (mm)	L (mm)	(g)	(pcs.)
503576	KO100P32/1	1	8	32	11	10
503577	KO100P32/2	2	8	32	11	10
503578	KO100P32/3	3	8	32	12	10
503579	KO100P32/4	4	8	32	12	10

Item Code	Part No.	100P.80 (PH)	D (mm)	L (mm)	(g)	(pcs.)
503580	KO100P80/1	1	8	80	30	10
503581	KO100P80/2	2	8	80	30	10
503582	KO100P80/3	3	8	80	31	10
503583	KO100P80/4	4	8	80	32	10

100S-32 · -80 ⊖ Bits for Slotted head

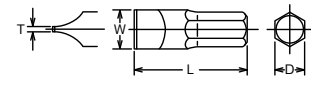

Item Code	Part No.	100S.32	T×W (mm)	D (mm)	L (mm)	(g)	(pcs.)
503584	KO100S3206	6	1 × 6	8	32	10	10
806245	KO100S3207	7	1 × 7	8	32	11	10
503585	KO100S3208	8	1.2× 8	8	32	12	10
503586	KO100S3209	9	1.6× 9	8	32	12	10
511489^	KO100S3210	10	1.6×10	8	32	13	10
503587	KO100S3211	11	1.6×11	8	32	15	10
503588	KO100S3212	12	2 ×12	8	32	18	10
503589	KO100S3214	14	2 ×14	8	32	21	10

Item Code	Part No.	100S.80	T×W (mm)	D (mm)	L (mm)	(g)	(pcs.)
503590	KO100S8006	6	1 × 6	8	80	29	10
503591	KO100S8007	7	1 × 7	8	80	30	10
503592	KO100S8008	8	1.2× 8	8	80	31	10
503593	KO100S8009	9	1.6× 9	8	80	32	10
806246	KO100S8010	10	1.6×10	8	80	33	10
503594	KO100S8011	11	1.6×11	8	80	33	10
503595	KO100S8012	12	2 ×12	8	80	34	10
806247	KO100S8014	14	2 ×14	8	80	37	10

100H-32 ⊙ Hex Bits

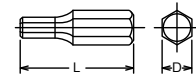

Item Code	Part No.	100H.32 (mm)	D (mm)	L (mm)	(g)	(pcs.)
503568	KO100H3203	3	8	32	11	10
503569	KO100H3204	4	8	32	11	10
503570	KO100H3205	5	8	32	12	10
503571	KO100H3206	6	8	32	12	10
503572	KO100H3208	8	8	32	13	10
503573	KO100H3210	10	8	32	16	10
503574	KO100H3212	12	8	32	23	10
503575	KO100H3214	14	8	32	29	10

100T-32 (T) ⊙ TORX® Bits

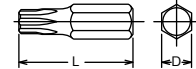

Item Code	Part No.	100T.32 (T)	D (mm)	L (mm)	(g)	(pcs.)
503596	KO100T35T10	T10	8	32	9	10
503597	KO100T35T15	T15	8	32	9	10
503598	KO100T35T20	T20	8	32	9	10
503599	KO100T35T25	T25	8	32	10	10
503600	KO100T35T27	T27	8	32	10	10
503601	KO100T35T30	T30	8	32	11	10
503602	KO100T35T40	T40	8	32	12	10
804801	KO100T35T45	T45	8	32	12	10

7/16" Bits & Holders

Z-SERIES

13134 ○ Impact Bit Holder

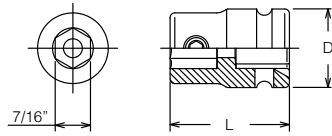

14134 ○ Impact Bit Holder

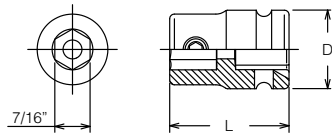

16134 ○ Impact Bit Holder

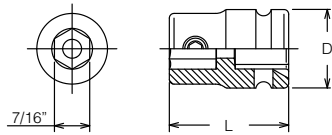

HAND SOCKETS

SCREWDRIVERS

IMPACT

Item Code	Part No.	□	D (mm)	L (mm)	⚖ (g)	📦 (pcs.)	⚡
806380^	KO13134	3/8"	22	32	70	10	*1
503759^	KO14134	1/2"	25	38	90	10	*2
807162	KO16134	3/4"	44	52	200	2	*3

*1 C-Ring=1302C,Pin/O-Ring=1302A/B

*2 C-Ring=1401C,Pin/O-Ring=1401A/B

*3 C-Ring=1600C,Pin/O-Ring=1601A/B

🔩 Replacement Screw : M8x5, ⚫ 4mm

For DIN3126 E11.2 Bits

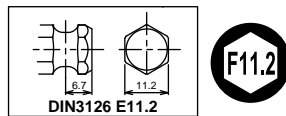

ACCESSORIES

183H-35 ● Hex Bits

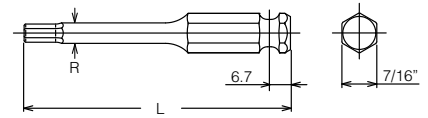

Item Code	Part No.	183H.35 (mm)	L (mm)	⚖ (g)	📦 (pcs.)
806718^	KO183H35M05	5	35	15	10
806719^	KO183H35M06	6	35	18	10
806720^	KO183H35M08	8	35	20	10
806717^	KO183H35M10	10	35	26	10

1/4" Adaptors

AUTOMOTIVE

110 Adaptors

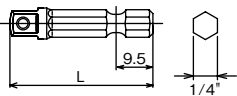

112 Adaptors

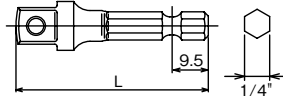

RENEWAL KITS



Item Code	Part No.	110	□	TYPE	L (mm)	⚖ (g)	📦 (pcs.)
503647^	KO110050	50B	1/4"	Ball	50	15	10
503648^	KO110100	100B		Ball	100	34	10
503649^	KO110150	150B		Ball	150	54	10

🔩 DIN 3126/ISO1173 Form E6.3

Item Code	Part No.	112	□	TYPE	L (mm)	⚖ (g)	📦 (pcs.)
503650	KO112050	50B	3/8"	Ball	50	21	10
503651^	KO112100	100B		Ball	100	71	10

🔩 DIN 3126/ISO1173 Form E6.3

Automotive Tools







Automotive Tools

Z-SERIES

3300C • 4300C Spark Plug Sockets with Spring Clips



Item Code	Part No.	3300C (mm)		D (mm)	l (mm)	L (mm)	H (mm)	(g)	(pcs.)
504572	KO3300C14	14		19	11	70	17	82	10
504573	KO3300C16	16		20.5	13	70	17	91	10
504574	KO3300C18	18		23.9	12	70	21	140	10
504575	KO3300C20.8	20.8		26.9	13.5	70	22	132	10



Item Code	Part Number	4300C (mm)		D (mm)	l (mm)	L (mm)	H (mm)	(g)	(pcs.)
504979	KO4300C16	16		21	13	70	21	101	10
806945	KO4300C18	18		23.9	12	70	21	132	10
504980	KO4300C20.8	20.8		26.9	13.5	70	22	130	10

HAND SOCKETS

SCREWDRIVERS

3300C/4 Spark Plug Sockets Set with Spring Clips





Item Code	Part No.		Socket Sets	(g)
504571	KO3300C/4		3300C: 4 Piece Set 14, 16, 18, 20.8	450

IMPACT

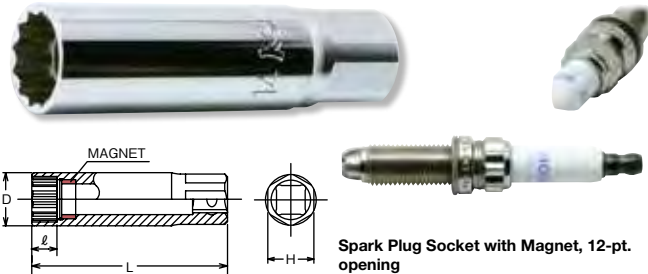
3305P Spark Plug Socket with Magnet, 12-pt. opening



Item Code	Part No.	3305P (mm)		D (mm)	l (mm)	L (mm)	H (mm)	(g)	(pcs.)
504631	KO3305P14	14		19	8	70	17	87	10
504632	KO3305P16	16		20.5	8	70	17	100	10



 The magnet could be broken with any impacts. Please handle with care.



ACCESSORIES

AUTOMOTIVE

3300S • 4300S Spark Plug Sockets with Rubber



Item Code	Part No.	3300S (mm)		D (mm)	l (mm)	L (mm)	H (mm)	(g)	(pcs.)
504599	KO3300S16	16		20.9	19	70	17	100	10
504600	KO3300S18	18		23.9	21	70	21	145	10
504601	KO3300S20.8	20.8		26.9	27	70	22	140	10

Item Code	Part No.	4300S (mm)		D (mm)	l (mm)	L (mm)	H (mm)	(g)	(pcs.)
505010^	KO4300S16	16		21	19	70	21	100	10
505011^	KO4300S18	18		23.9	21	70	21	130	10
505012^	KO4300S20.6	20.8		26.9	27	70	22	135	10

RENEWAL KITS

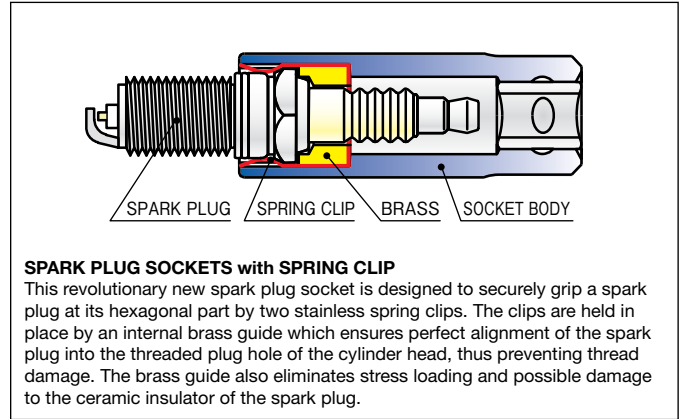





SPARK PLUG SOCKETS with SPRING CLIP

This revolutionary new spark plug socket is designed to securely grip a spark plug at its hexagonal part by two stainless spring clips. The clips are held in place by an internal brass guide which ensures perfect alignment of the spark plug into the threaded plug hole of the cylinder head, thus preventing thread damage. The brass guide also eliminates stress loading and possible damage to the ceramic insulator of the spark plug.

3340C • 4340C Universal Spark Plug Sockets with Spring Clips





Item Code	Part Number	3340C (mm)		D ₁ (mm)	D ₂ (mm)	l (mm)	L (mm)	(g)	(pcs.)
806887^	KO3340C16	16		21	19	13	88	122	10
806888^	KO3340C18	18		23.9	19	12	88	145	10
806889^	KO3340C20.8	20.8		26.8	19	13.5	88	174	10

Item Code	Part Number	4340C (mm)		D ₁ (mm)	D ₂ (mm)	l (mm)	L (mm)	(g)	(pcs.)
505915	KO4340C-16	16		21	25	13	100	220	10
505916	KO4340C-20.8	20.8		26.8	25	13.5	100	250	10

3345P Universal Spark Plug Socket with Magnet, 12-point opening



Item Code	Part Number	3345P (mm)		D ₁ (mm)	D ₂ (mm)	l (mm)	L (mm)	(g)	(pcs.)
806890^	KO3345P14	14		19	19	8	88	110	10

 The magnet could be broken with any impacts. Please handle with care.

Automotive Tools

127C T-type Universal Spark Plug Socket Wrench

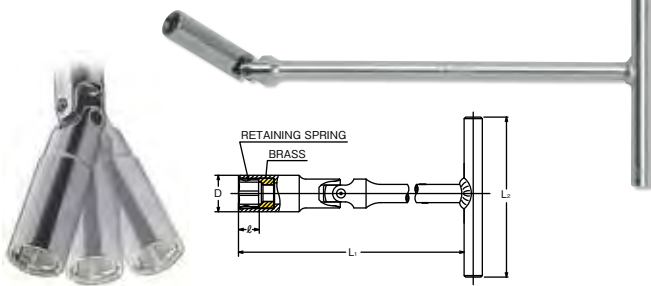

Item Code	Part No.	127C.315 (mm)	D (mm)	ℓ (mm)	L1 (mm)	L2 (mm)	⚖️ (g)	📦 (pce.)
806377^	KO127C14	14	19	11	315	150	520	1
806378^	KO127C16	16	21	13	315	150	530	1
505637^	KO127C18	18	23.9	12	315	150	590	1
806379^	KO127C20.8	20.8	26.8	13.5	315	150	590	1

3751N Torque Ratchet for Spark Plugs



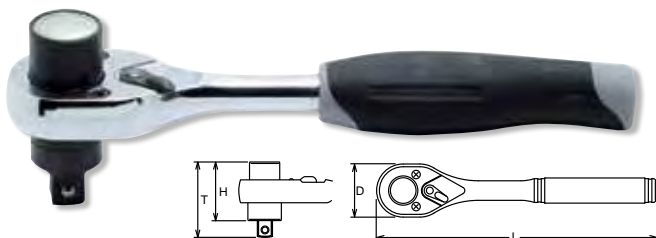

3751J Torque Ratchet for Spark Plugs



TORQUE RATCHET

The torque is set at 25Nm. When the torque is loaded higher than 25Nm, the gear slips and no increased torque is transmitted. Cylinder heads and spark plugs are protected by this mechanism.

Item Code	Part Number	⚡	D (mm)	T (mm)	H (mm)	L (mm)	⚖️ (g)	📦 (pce.)
504754^	KO3751N		34	57	43	178	320	1
505891^	KO3751J		34	57	43	178	320	1

3225A Set for Torque Controlled Installation of Spark Plugs



TORQUE RATCHET

The torque is set at 25Nm. When the torque is loaded higher than 25Nm, the gear slips and no increased torque is transmitted. Cylinder heads and spark plugs are protected by this mechanism.

4 Piece Set
METAL CASE: W215xH80xT47mm ⚖️ (g) = 960

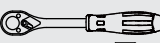
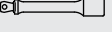

Item Code	Part No.	Sockets	Accessories
504551^	KO3225A	 3300C Spark Plug Sockets 16, 20.8	 3751J-25  3763-125

SP4300M-85 Special socket for Lambda Probes

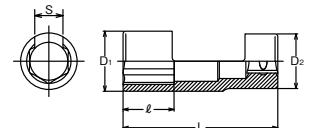
SP4300M-110





FLARE NUT SOCKET
Socket for Lambda Probes
Open section allows for use with wire/connector.

Item Code	Part Number	⚡	D1 (mm)	D2 (mm)	ℓ (mm)	L (mm)	S (mm)	⚖️ (g)	📦 (pcs.)
505619^	KOSP4300M-85/22		33	30	29	85	8	228	10
807039^	KOSP4300M-110		33	30	34	110	8	279	10

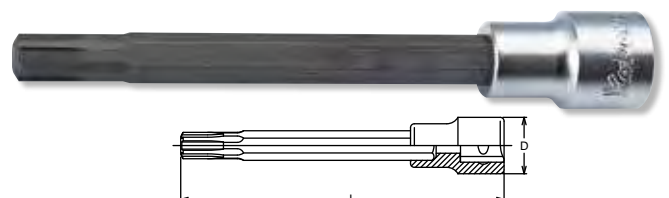
ST4027-140 Head Bolt Bit Socket for VW/AUDI





Item Code	Part No.	⚡	D (mm)	L (mm)	⚖️ (g)	📦 (pcs.)
505620	KOST4027.140		23	140	155	10

  Head Bolt Bit Socket for VW/AUDI
ST4027-140 can not substitute with 3027, 4027-CV bit series.

4202 Drain Plug Keys Set



7 Piece Set
METAL CASE: W190xH59xT45mm ⚖️ = 426g

Item Code	Part No.	Sockets
504919	KO4202	 106 Drain Plug Keys 8Sx10S, 8Hx3/8H, 10Hx11H, 12Hx13H, 14Hx17H, 19H  4102 Drain Plug Key Adaptor

106 4-point Male bits





Item Code	Part No.	H (mm)	ℓ1 (mm)	ℓ2 (mm)	L (mm)	⚖️ (g)	📦 (pcs.)
503625^	KO106-8SX10S	17	8	8	32	40	10
505627^	KO106-8HX3/8H	17	8	8	32	38	10
806276^	KO106-10HX11H	17	8	8	32	42	10
806277^	KO106-12HX13H	17	8	8	32	47	10
806278^	KO106-14HX17H	17	8	8	32	55	10
806279^	KO106-19H	17	-	8	24	49	10

Automotive Tools

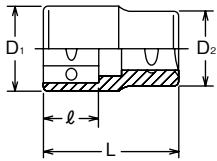

4102 Adaptor for 106 Drain Plug Key



Item Code	Part No.	4102 (mm)		D ₁ (mm)	D ₂ (mm)	ℓ (mm)	L (mm)	(g)	(pcs.)
806932 [^]	KO410217	17		25	24	16	40	82	10

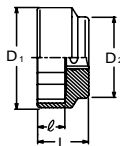

3400M-24 6-point Sockets Vasos Hexagonales

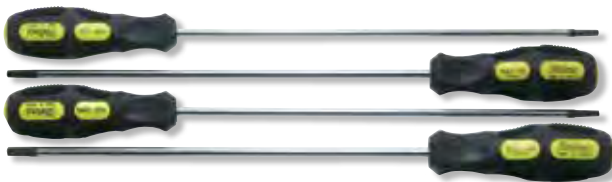

Item Code	Part No.	3400M.24 (mm)		D ₁ (mm)	D ₂ (mm)	ℓ (mm)	L (mm)	(g)	(pcs.)
806896	KO3400M-24/27MM	27		36.5	21.5	13.5	24	76	10
806897	KO3400M-24/30MM	30		40	25	13.5	24	91	10
806898	KO3400M-24/32MM	32		42.8	28	13.5	24	108	10
806899	KO3400M-24/36MM	36		47.2	32	13.5	24	135	10

1212 Screwdriver Set





Item Code	Part No.	4 Piece Set in Plastic bag	(g)
806308	KO1212	 168T(250): 20IPR	380
		 168T(250): T20, T25, T30	



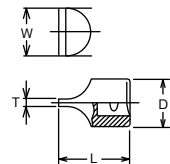

Long shank Screw Screwdriver

4101 • 6101 Drag Link Socket for Slotted Heads



Item Code	Part No.		T×W (mm)	D (mm)	L (mm)	(g)	(pcs.)
504905	KO4101/1		2.7×18.6	22	40	59	10
504906	KO4101/2		3.7×24	24	40	79	10
504907	KO4101/3		3.7×30	30	40	128	10

Item Code	Part No.		T×W (mm)	D (mm)	L (mm)	(g)	(pcs.)
505275	KO6101		6.4×33.5	35	50	205	10

155 Tyre Lever

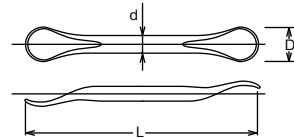



Item Code	Part No.	D (mm)	d (mm)	L (mm)	(g)	(pcs.)
503899 [^]	KO155	22	10	170	100	10

For Motor Cycles

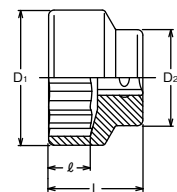
6405A-MV Rear Wheel Nut Socket



Item Code	Part No.	6405A		D ₁ (mm)	D ₂ (mm)	ℓ (mm)	L (mm)	(g)	(pcs.)
807004	KO6405A-MV	2.3/16MV		74.6	53	23	52	790	2





For MV AGUSTA



Rear Wheel Nut

Automotive Tools

4400M-DU  Rear Wheel Nut Socket
4405M-DU 



Item Code	Part Number	4400M		D ₁ (mm)	D ₂ (mm)	ℓ (mm)	L (mm)	(g)	(pcs.)
806961	KO4400M-DU41	41DU		53	45	15	28	240	5
806962	KO4400M-DU46	46DU		59	48	15	28	280	5

Item Code	Part Number	4405M		D ₁ (mm)	D ₂ (mm)	ℓ (mm)	L (mm)	(g)	(pcs.)
806970	KO4405M-DU36	36DU		47.3	41	15	28	200	5
806971	KO4405M-DU55	55DU		71	52	16	31	410	5

14201M  Wheel Nut Sockets Set
Extra Thin-walled 



3 Piece Set
 CARDBOARD BOX:W125xH95xT34mm  = 690g

Item Code	Part No.	Sockets
503770	KO14201M	14145PM.110 Impact Wheel Nut Sockets 17, 19, 21

 Please note that thin walled design is only for wheel nut work and Torque rating is limited.

14145PM-110  Wheel Nut Sockets,
Extra Thin-walled 

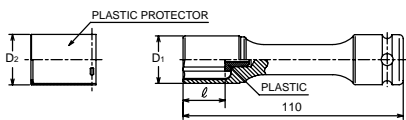







A detachable plastic protector is fitted to the socket to prevent damage to the wheel when working in tight areas. The socket size and Ko-ken mark printed on the shaft makes it easier to see if the socket is still rotating or stopped.



Impact Wheel Nut Sockets-Extra Thin wall
 Special design for wheel nut work.
 -110mm length gives socket extra reach for nuts recessed deep inside the wheel and ideal for Aluminum wheel nuts where access to nut is very tight.
 -Blue (17mm), Red (19mm), Yellow (21mm) and White (22mm), **colour coded shafts** make size identification easy.
 -**Plastic insert** helps prevent damage to the wheel nut.

 Please note that thin walled design is only for wheel nut work and Torque rating is limited.

Item Code	Part No.	14145PM.110 (mm)		D ₁ (mm)	D ₂ (mm)	ℓ (mm)	Shaft Color	(g)	(pcs.)	
503765	KO14145PM17	17		23.7	25.2	21	Blue	223	5	*1
503766	KO14145PM19	19		25.7	27.2	23	Red	231	5	*1
503767	KO14145PM21	21		27.5	29	25	Yellow	236	5	*1
806448	KO14145PM22	22		29	30.5	26	White	238	5	*1

*1 C-Ring=1401C, Pin/O-Ring=1401A/B

280PM  Adaptor Socket for Low Profile Wheel Nut 

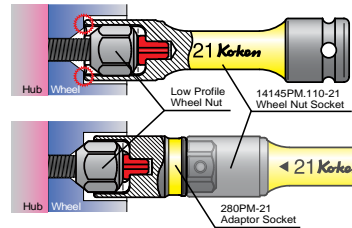

Designed for low profile wheel nut sockets.

Detachable plastic protector is fitted to the adaptor to prevent damage to painted or surface treatment area on the wheel.

The plastic insert located inside of the adaptor helps prevent damage to the wheel nut.

Colour coded band to make size identification easy.

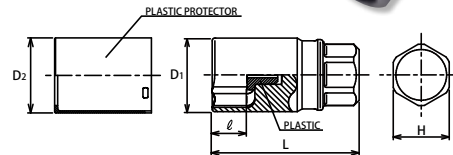

Item Code	Part No.	280PM (mm)	D ₁ (mm)	D ₂ (mm)	ℓ (mm)	L (mm)	H (mm)	Shaft Color	(g)	(pcs.)
806814	KO280PM19	19	25.7	27.2	13	52	19	Red	150	5
806815	KO280PM21	21	27.5	29	13	55	21	Yellow	180	5



Z-SERIES

HAND SOCKETS

SCREWDRIVERS

IMPACT

ACCESSORIES

AUTOMOTIVE

RENEWAL KITS

Automotive Tools

Z-SERIES

HAND SOCKETS

SCREWDRIVERS

IMPACT

ACCESSORIES

AUTOMOTIVE

RENEWAL KITS

14118M · 14118A Wheel Nut Sockets, Double Ended

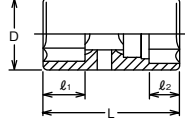



Item Code	Part No.	14118M (mm)		D (mm)	l1 (mm)	l2 (mm)	L (mm)	(g)	(pcs.)
503761^	KO14118M1921	19x21		28	15.5	13	48	150	10
503762^	KO14118M1922	19x21	1/2"	31	17.5	15	57	177	10
503763^	KO14118M2122	21x22		31	17.5	15	57	187	10

Item Code	Part No.	14118A (inch)		D (mm)	l1 (mm)	l2 (mm)	L (mm)	(g)	(pcs.)
503760^	KO14118A2426	3/4x13/16	1/2"	30	17.5	13	57	185	10

14124/3 Lock Nut Busters (Double Ended) in set



3 Piece Set
CARDBOARD BOX: W125xH91xT43mm  = 580g

Item Code	Part No.	Sockets	Accessories
503764	KO14124/3	14124: Lock Nut Buster 21x24.5 26x27.5	 14760-75B

8102M-400 Extra long Sockets for Wheel Nuts



 8102M are for hand use only. Do not use with a power or impact wrench.

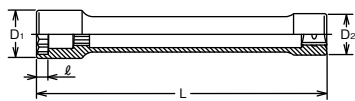



Extra long Socket for wheel nut

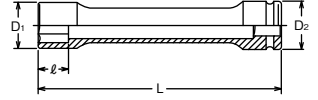

Item Code	Part Number	8102M.400 (mm)		D1 (mm)	D2 (mm)	l (mm)	L (mm)	(g)	(pcs.)
807010^	KO8102M-40032	32		48.5	49.9	32	400	2210	1
807011^	KO8102M-40033	33	1"	49.8	49.9	32	400	2220	1

16102M-270 · -400 Extra long Sockets for Wheel Nuts



Item Code	Part No.	16102M.270 (mm)		D1 (mm)	D2 (mm)	l (mm)	L (mm)	(g)	(pce.)	
806551^	KO16102M27024	24		38.8	44	24	270	1034	1	*1
806552^	KO16102M27027	27		42.5	44	27	270	1088	1	*1
806553^	KO16102M27030	30		46.3	44	30	270	1144	1	*1
806554^	KO16102M27032	32		48.8	44	32	270	1157	1	*1
505786^	KO16102M270/33	33	3/4"	50	44	32	270	1200	1	*1
806555^	KO16102M27036	36		53.8	44	32	270	1250	1	*1
806556^	KO16102M27038	38		56.3	44	32	270	1610	1	*1
806557^	KO16102M27041	41		60	44	32	270	1640	1	*1



*1 C-Ring=1600C, Pin/O-Ring=1601A/B

Item Code	Part No.	16102M.400 (mm)		D1 (mm)	D2 (mm)	l (mm)	L (mm)	(g)	(pce.)	
806558^	KO16102M40024	24		38.8	44	24	400	1430	1	*1
806559^	KO16102M40027	27		42.5	44	27	400	1460	1	*1
806560^	KO16102M40030	30		46.3	44	30	400	1510	1	*1
806561^	KO16102M40032	32	3/4"	48.8	44	32	400	1530	1	*1
806562^	KO16102M40033	33		50	44	32	400	1530	1	*1
806563^	KO16102M40036	36		53.8	44	32	400	2180	1	*1

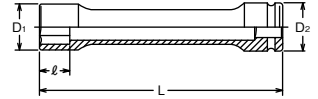

*1 C-Ring=1600C, Pin/O-Ring=1601A/B

18102M-270 · -400 Extra long Sockets for Wheel Nuts



Item Code	Part No.	18102M.270 (mm)		D1 (mm)	D2 (mm)	l (mm)	L (mm)	(g)	(pce.)	
806688^	KO18102M27023	23		37.3	54	23	270	1627	1	*1
806689^	KO18102M27024	24		38.5	54	24	270	1628	1	*1
806690^	KO18102M27026	26		41	54	26	270	1667	1	*1
806691^	KO18102M27027	27		42.3	54	27	270	1680	1	*1
806692^	KO18102M27029	29		44.8	54	29	270	1680	1	*1
806693^	KO18102M27030	30		46	54	30	270	1680	1	*1
806694^	KO18102M27032	32	1"	48.5	54	32	270	1680	1	*1
806695^	KO18102M27033	33		49.8	54	32	270	1700	1	*1
806696^	KO18102M27034	34		51	54	32	270	1750	1	*1
806697^	KO18102M27036	36		53.5	54	32	270	1750	1	*1
806698^	KO18102M27038	38		56	54	32	270	1822	1	*1
806699^	KO18102M27041	41		60	54	32	270	1800	1	*1

*1 C-Ring=1801C, Pin/O-Ring=1801A/B

Item Code	Part No.	18102M.400 (mm)		D1 (mm)	D2 (mm)	l (mm)	L (mm)	(g)	(pce.)	
806700^	KO18102M40023	23		37.3	54	23	400	1865	1	*1
806701^	KO18102M40024	24		38.5	54	24	400	1869	1	*1
806702^	KO18102M40026	26		41	54	26	400	1925	1	*1
806703^	KO18102M40027	27		42.3	54	27	400	2272	1	*1
806704^	KO18102M40029	29		44.8	54	29	400	2278	1	*1
806705^	KO18102M40030	30		46	54	30	400	2266	1	*1
806706^	KO18102M40032	32	1"	48.5	54	32	400	2322	1	*1
806707^	KO18102M40033	33		49.8	54	32	400	2320	1	*1
806708^	KO18102M40034	34		51	54	32	400	2341	1	*1
806709^	KO18102M40036	36		53.5	54	32	400	2442	1	*1
806710^	KO18102M40038	38		56	54	32	400	2550	1	*1





*1 C-Ring=1801C, Pin/O-Ring=1801A/B

Automotive Tools

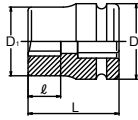
PS6

Rear Wheel Nut Sockets







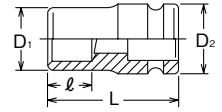

Item Code	Part No.	PS6 (mm)		D ₁ (mm)	D ₂ (mm)	ℓ (mm)	L (mm)			
807029 [^]	KOPS6-17	17		40	44	19	53	433	5	*1
807030 [^]	KOPS6-19	19		40	44	19	53	419	5	*1
807031 [^]	KOPS6-20	20		44	44	21	55	483	5	*1
807032 [^]	KOPS6-21	21		44	44	23	57	491	5	*1

*1 C-Ring=1600C, Pin/O-Ring=1601A/B

16317M

Rear Wheel Nut Sockets







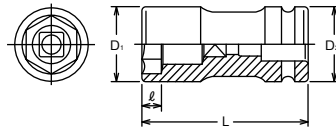

Item Code	Part No.	16317M (mm)		D ₁ (mm)	D ₂ (mm)	ℓ (mm)	L (mm)			
503971 [^]	KO16317M17	17		40	44	22.5	67	485	1	*1
503972 [^]	KO16317M19	19		40	44	22.5	67	462	1	*1
503973 [^]	KO16317M20	20		44	44	22.5	67	517	1	*1
503974 [^]	KO16317M21	21		44	44	22.5	67	489	1	*1
503975 [^]	KO16317M22	22		44	44	22.5	67	482	1	*1

*1 C-Ring=1600C, Pin/O-Ring=1601A/B

16316M

Rear Wheel Nut Sockets



Item Code	Part No.	16316M (mm×mm)		D ₁ (mm)	D ₂ (mm)	ℓ (mm)	L (mm)			
503967 [^]	KO16316M3517	35×17		52	44	10	90	865	1	*1
503968	KO16316M3820	38×20		56	44	13	100	952	1	*1
503969	KO16316M4119	41×19		59	44	12	100	1037	1	*1
503970	KO16316M4121	41×21		59	44	15	100	963	1	*1





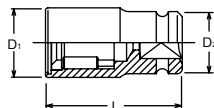

*1 C-Ring=1600C, Pin/O-Ring=1601A/B

Construction

BD004

Impact Screw and Stud Setters



Item Code	Part No.	BD004 (mm)		D ₁ (mm)	D ₂ (mm)	L (mm)			
807022 [^]	KOBD00410	12.5×10		30	25	70	236	5	*1
804674 [^]	KOBD00413	12.5×13		38	30	75	388	5	*2
804675	KOBD00416	12.5×16		38	30	75	369	5	*2
807023 [^]	KOBD00419	20 ×19		48	44	90	775	2	*3
804676 [^]	KOBD00422	20 ×22		48	44	90	752	2	*3
807024 [^]	KOBD00425	20 ×25		62	44	95	1184	2	*3
807025 [^]	KOBD00429	20 ×29		62	44	95	1148	2	*3

*1 C-Ring=1401C, Pin/O-Ring=1401A/B

*2 C-Ring=1402C, Pin/O-Ring=1402A/B

*3 C-Ring=1600C, Pin/O-Ring=1601A/B



Disclaimer: Every effort has been made to publish the correct details in this brochure. No responsibility will be taken for errors, omissions or changes in product specifications. [^] Special Order Only

Repair Kits

Ratchet Repair Kits

2753RK 2753N, 2753PS, 2753P, 2753P-160, 2753J, 2774PS, 2774JS, 2774N, 2774P, 2774J



3753RK 3753SM, 3753N, 3753P, 3753P-250, 3753J, 3774PS, 3774P-SR, D3753J, 3774N, 3774P, 3774J, 3774NL, 3774PL, 3774JL



4753RK 4753N, 4753P, 4753P-410, 4753J, D4753J, 4774N, 4774P, 4774P-450, 4774J



6749RK 6749, 6749-1000 AFTER MAY 2009

6749RK-2 BEFORE MAY 2009



Hinge Handle Repair Kits

3768RK 3768N, 3768P, 3768J



4768RK 4768N, 4768P, 4768J, 4781N-450



6768RK 6768



Item Code	Part No.	□	(g)	(pce.)
504411	KO2753RK	1/4"	30	1
504762	KO3753RK	3/8"	76	1
505230	KO4753RK	1/2"	130	1
505431	KO6749RK	3/4"	580	1
505432	KO6749RK-2	3/4"	580	1

Item Code	Part No.	□	(g)	(pce.)
504790	KO3768RK	3/8"	21	1
505254	KO4768RK380	1/2"	60	1
505442	KO6768RK	3/4"	200	1

Can't find the renewal kit you're looking for? Contact our customer service on 1300 780 876 to order the appropriate renewal kit for your tool.

TORX®/TORXplus® BITS

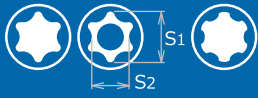
			S1 (mm)	S2 (mm)
T6	6IP		1.7	1.2
T7	7IP		2.0	1.4
T8	8IP		2.3	1.7
T9	9IP		2.5	1.8
T10	10IP		2.7	2.0
T15	15IP		3.3	2.3
T20	20IP		3.9	2.8
T25	25IP		4.5	3.2
T27	27IP		5.0	3.6
T30	30IP		5.6	4.0
T40	40IP		6.7	4.8
T45	45IP		7.9	5.6
T50	50IP		8.9	6.2
T55	55IP		11.3	8.0
T60	60IP		13.3	9.5
T70	70IP		15.6	11.1
T80	80IP		17.6	12.7
T90	90IP		20.0	14.2
T100	100IP		22.2	15.8

TORXplus® With Hole BITS

			S1 (mm)	S2 (mm)
8IPR			2.2	2.0
9IPR			2.4	2.2
10IPR			2.6	2.4
15IPR			3.1	2.8
20IPR			3.6	3.3
25IPR			4.1	3.8
27IPR			4.7	4.3
30IPR			5.2	4.8
40IPR			6.3	5.7
45IPR			7.4	6.7
50IPR			8.4	7.6
55IPR			10.6	9.7

XZN BITS

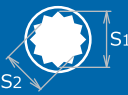
			S1 (mm)	S2 (mm)
M4			3.6	3.1
M5			4.8	4.1
M6			6.1	5.1
M8			7.3	6.1
M10			9.7	8.1
M12			11.5	9.7
M14			13.3	11.2
M16			15.7	13.2
M18			16.9	14.2

TORX®/TORXplus® SOCKETS

			S1 (mm)	S2 (mm)
E4	4EP		3.7	2.7
E5	5EP		4.6	3.3
E6	6EP		5.6	4.0
E7	7EP		6.1	4.3
E8	8EP		7.4	5.3
E10	10EP		9.3	6.8
E11	11EP		9.9	7.1
E12	12EP		11.0	7.9
E14	14EP		12.8	9.2
E16	16EP		14.6	10.5
E18	18EP		16.5	11.9
E20	20EP		18.3	13.2
E22	22EP		20.1	14.8
E24	24EP		22.0	15.7
E26	26EP		23.7	17.5
E28	28EP		25.5	18.3
E30	30EP		27.3	20.0
E32	32EP		29.0	21.3

LHSTIX® (LH-S) SOCKETS

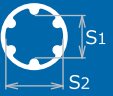
			S1 (mm)	S2 (mm)
LH3S			3.8	4.7
LH4S			4.5	6.0
LH5S			5.6	7.5
LH6S			6.8	9.0
LH7S			7.9	10.5
LH8S			9.0	12.0
LH10S			11.3	15.0
LH12S			13.6	18.0
LH14S			15.8	21.0
LH16S			18.1	24.0

Ribe CV BITS

			W (mm)	S1 (mm)	S2 (mm)
M5			1.2	5.0	3.8
M6			1.3	6.0	4.5
M7			1.4	7.0	5.0
M8			1.8	8.0	6.0
M9			2.0	9.0	7.1
M10			2.3	10.0	7.4
M12			2.6	12.0	9.0
M13			3.1	13.0	11.0
M14			3.2	14.0	10.4
M16			3.6	16.0	11.9

TORX® is a registered trademark of Acument Intellectual Properties, LLC.
 TORX® es una marca registrada de Acument Intellectual Properties, LLC.
 TORXplus® is a registered trademark of Acument Intellectual Properties, LLC.
 TORXplus® es una marca registrada de Acument Intellectual Properties, LLC.
 LHSTIX® is a registered trademark of OSG CORPORATION System Engineering Department.
 LHSTIX® es una marca registrada de OSG CORPORATION System Engineering Department.

Available from your Ko-ken distributor:

P_AUS_T_KOKEN_BR_2020

WHITE INTERNATIONAL PTY LTD

60 Ashford Ave Milperra NSW 2214
PO Box 304 Milperra NSW 2214
Phone 02 9783 6000 Fax 02 9783 6001
Customer Service 1300 780 876
Email Sales: sales@whiteint.com.au
www.whiteint.com.au



Please always refer to our website for further technical information & new product innovations

Disclaimer: Every effort has been made to publish the correct details in this brochure. No responsibility will be taken for errors, omissions or changes in product specifications. Product images are representations only.

Scan QR Code on your smart phone or iPad to save a digital version.

